

Barton



55th EDITION





For more than seventy years, Barton Marine has set the benchmark for high quality marine deck hardware. Our products are made in the UK at our purpose-built factory in Whitstable on the North Kent Coast, with a range running to more than 2,000 specialist products. Through our trusted distribution partners, our products can be found in leading chandleries around the world in more than 40 countries. Barton Marine pioneered the use of fabric based laminated plastic called Tufnol back in 1948 and we continue to innovate at the forefront of research and development in the use of lightweight, high-performance technology for today's demanding sailor.



British made since 1948

CONTENTS

About us	3
Editor's letter	7
Product Guide	8
Heart of the Barton Block	9
Boat Size Guide Blocks	10
Boat size Guide Traveller Systems	11
Block System Traveller Diagrams	12
Traveller System Diagrams	13
Blocks	
20mm Size 0	16
30mm Size 1	18
35mm Size 2	20
45mm Size 3	22
54mm Size 4/5	24
64mm Size 6	26
70mm Size 7	28
Traditional Barton Range	30
Classic Wooden Blocks	
Victory Collection	32

Snatch Blocks	34
Stainless Steel Blocks	35
Industrial Blocks & Block on a Strop	36
Wire Rope Blocks	37
High Load & Foot Blocks	38
Barton Innovation	40
High Load Eyes	42

Traveller Systems 45

Removable Mainsheet System	46
----------------------------	----

Mainsheet Systems

Modular Components	48
Travellers	49
End Fittings	51

Track

Modular Components	52
Track 20mm/26mm/30mm	



Mainsheet System

19mm I Section Track & Travellers	53
24mm I Section Track & Travellers	54
28mm I Section Track & Travellers	55
Towable Genoa Car Systems	56
Towable T Track Genoa Cars	57
20mm T Section Track	58
25mm T Section Track	60
32mm T Section Track	62
Bespoke Track Systems	64
Deck Organisers	67
Rope Clutches & Mast Base Organisers	68
Barton DO 550 Clutches	69
Winch Handles & Accessories	70
Barton Composite Winches	71
The Barton 'Wincher'	72
Lazy Jack Kits & Mast Step	74
Reefing Kits & Hooks	75
Barton Boomstrut	76
The Dinghy & Cruiser Boomstrut	77
Wear Pads & Line Tamers	78

Dinghy & Dayboats Equipment

Traveller Systems	79
Tiller Extensions	80
Carbon Tiller Extensions	81
Dinghy & Dayboat	82
Replica Laser Kits	83
Dinghy Mast Support	84
Furling Gear	85
Kevlar Cam Cleats	86
Inspection Covers	88
Bullseyes, Pad Eyes & Deck Eyes	91
Clevis Pins, Split Rings & Springs	92
Shackles & 'S' Hooks	93
Clam Seal	94
Special Cleats	95
Sheaves	96
Fuel Whistle & Easy Splice	97
Part Number Index	98



1968

SUPERIOR
lightweight
YACHT FITTINGS

Manufacturers of
TUPHblox
TUPH fittings
Saylor **BYRON** **BOAAT** **BOATPARTS**

R.S.J. Barton LIMITED
 144-145 CROSWELL ROAD,
 WHITEHALL, KENT TN26 2JZ

1978

Barton
easy rollers

a superb range of free running ball bearing blocks

1981

NEW YACHT EQUIPMENT
for the '80s

The Barton HALLIARD CLUTCH

Part No. 502
Anchor Size

Patent applied for
Registered Design No. 807475

The BARTON Halliard Clutch has been designed as a safe device for securing a rope halliard. The Halliard can be released from the clutch with one finger, even when heavily loaded. This supersedes other types of hauled stoppers, which it is necessary to unlock in the halliard and take load off the stopper before it can be released.

The second important advantage of the BARTON Halliard Clutch is that the sail can be hoisted with the load in the locked down position as the rope passes freely in one direction, but it is restricted from returning against the load imposed by the sail by a manganese bronze spring-loaded catch.

The BARTON Halliard Clutch is a robust and ergonomically designed piece of additional deck hardware which can be used with any type of rope hoisting efficiency to secure the Genoa and Downhaul Vangels on most modern cruising yachts up to approximately 30 ft. in length. It can hold a load of up to 500 lbs. using 1/2 inch rope.

FEATURES
 Precision steel, load rated pulley blocks
 stainless steel case - stainless steel roller
 stainless roller

DIMENSIONS

LENGTH	4 1/2"	188 mm
WIDTH	1 1/2"	38 mm
HEIGHT	2 1/2"	63 mm
PIVOT BOLT CENTRES	2 1/2"	63.5 mm
BOLTS REQUIRED	3 7/8"	97 mm dia
ROPE CAPACITY	8 - 10 mm	

Three models are available. Single Unit as illustrated, a Double Unit and a Triple Unit. The locking levers are supplied in three distinctive colours, Black, White and Red for halliard identification. When ordering please state pattern number required.

Single Unit Part No. 502
 Double Unit Part No. 501
 Triple Unit Part No. 503

Barton
YACHT EQUIPMENT

1983

Barton

R.S.J. BARTON LIMITED
 144-145 Croswell Road, Whitehall, Kent TN26 2JZ, England
 Telephone: Whitehall (0227) 273917, Telex 955302

1984

Barton

YACHT EQUIPMENT

1987

Barton

1991

Barton

The Barton Catalogue

1999

Barton
nautilus
winches

2016

Barton
bartonmarine.com
Marine Equipment Catalogue

Control the power

**"...engineered
to improve
strength and
performance."**

Welcome to the 55th edition of the Barton Catalogue. This is the first issue to include the complete range of our new generation of blocks, launched in 2018. Through our innovative design process we've produced a block range which is smaller, lighter and stronger for today's demanding sailor. The new generation block range has been engineered to improve strength and performance – all offering greater load ratings and protection against the elements. You'll notice how the steel frame is encased inside the glass fibre side plates and we've updated the colour to a darker, richer slate grey.

Our Victory range of classic wooden blocks continues to expand. Designed for the sailor who is looking for a classic look, but with all the performance and qualities of our core range. The Victory range is much lighter than traditional wooden blocks and offers ball bearing block performance.

As Barton Marine enters its 8th decade of manufacturing, we present the 55th edition of the Barton Catalogue. It's interesting to look back at past covers to see how our brand has changed over the years since Ron Barton first launched the company in 1948. Ron was a keen sailor himself and the founding principle of the company was to produce a range of hardware designed by sailors, for sailors. Today, the product range runs to over 2,000 products.

We remain committed to investing in manufacturing in the UK. All our products are researched, designed, manufactured and assembled in our headquarters in Whitstable, on the North Kent Coast. Our knowledgeable Barton Team members are happy to offer technical advice, distributor information and equipment suggestions for rigging your boat.

Suzanne Blaustone

CEO

PRODUCT GUIDE

To ensure your safety, your yacht's performance and to make certain that you get best value for money, we provide guides to clarify your deck gear choices.

The diagrams on page 12 and 13 explain how to achieve many tasks from increasing the purchase on your kicker system to ensuring your halyards are lead back into the cockpit correctly.

Our suggested boat size table on page 10 & 11 is designed to help you correctly identify the right size of product for your application. From picking the correct size of blocks for your mainsheet system to ensuring you have the right size and type of blocks for your mast base, we provide some simple rules to consider when choosing a product.

Our team of experienced sailors are always available to assist you when making choices. Please contact us by phone or email at any time.

Some tips when selecting and fitting blocks...

- Ensure the block is strong enough for the job required (rope capacity does not denote strength).
- Plain bearing versus ball bearing sheave – ball bearing sheaves do not hold the same load as plain sheaves – see page 9 for advice
- Check line capacity is sufficient. A tight fit will increase friction, and cause wear to the block and line.
- Always ensure a fair lead. Blocks are designed to have the load running directly through the central axis.
- Never load one sheave of a double block.
- When fitting blocks always ensure that there is sufficient articulation.
- When fitting cam cleat blocks, ensure that the cam cleat is set at the correct angle to allow easy release.
- Foot blocks & cheek blocks should always be through-bolted for maximum strength.

Care of blocks and deck fittings...

- Regularly rinse blocks and deck fittings with fresh water to remove salt.
- Ensure that sheaves run freely.
- Check all blocks on a regular basis.
- Check shackles for signs of strain or overload.
- Inspect cam cleats for excessive wear.



IMPORTANT
SAFETY
INFORMATION

Foot Blocks: Fastenings of the minimum diameter suggested should be used to gain full load capacity. Ensure that suitable mounting pads are provided under deck. Stacking blocks to achieve doubles will reduce working loads quoted.

Boat Sizes: Suggested boat sizes are given as guidance only and assume a monohull with boom end sheeting, loaded vertically to the traveller. Mid-boom sheeting, severe angled take offs and curved tracks can impose greater loads and suitable allowances should be made for this. If at all unsure of your choice it is important to seek further advice. If you are close to the maximum boat size suggested, we would advise upgrading to a Torlon package, long car or the next size up.

Mast Steps: Mast steps should always be used in conjunction with a Bosun's chair. Always have a crew member at hand to control the halyard. Do not go aloft barefoot and always put safety first when going aloft.

Available Fixtures

Fixed Eye

A plain attachment eye.



Snap Shackle

A cast stainless steel swivelling snap shackle - ideal for quick release downhauls or vang.



Becket

All the appropriate blocks are available with or without becket.



Swivel

Range of 316L stainless steel high load performance swivel shackles.



Double Tang

For use with the Barton mast base organiser.



Variloc

Allows the swivel to rotate fully or be locked at one of 3 angles.



Reverse Shackle

Allows the shackle to be turned through 90°.



HEART OF THE BARTON BLOCK

“The Sheave”

Barton Plain Bearing Blocks

All Barton plain bearing blocks have a precision moulded Acetal sheave running on a large diameter brass bearing, ensuring free running under the highest of loads.



The Barton Ball Bearing Option

All Barton blocks from series 0 to size 7 offer the option of a high performance, low friction ball bearing sheave.



Plain bearing versus ball bearing sheaves

Use a plain bearing sheave for a high static load; for example mast base, (main and genoa) mast head and kicker or when the sheave will be under a high load and the sheave will turn infrequently.

Use a ball bearing sheave where fast, constant adjustment is required, for example mainsheets or spinnaker sheets.



Mast base organiser

Barton ball bearing sheaves are proven time and again to provide the best performance and efficiency in independent tests conducted by UK and European sailing magazines concluded Barton is the “best buy” choice among the competition.

An explanation

Our design features twin rows of Acetal balls running on a large diameter centre boss. This enables the load bearing surface to be maximised over the greatest number of bearings, giving higher performance in all directions.

Ball bearing blocks to the unique Barton design bring you the possibility of upgrading your block systems at a realistic cost.

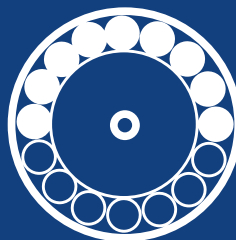

Barton roller sheave

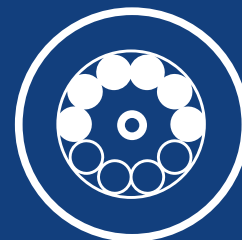

Competitor roller sheave

Load direction
↓

More ball bearings used result in increased capability and less rolling resistance

Friction is reduced by 23% when using a Barton ball bearing sheave compared to a plain sheave.

←23%

BOAT SIZE GUIDE

Important note: boat sizes

Suggested boat sizes are given as a guidance only and assume a monohull with boom end sheeting, loaded vertically to the traveller.

Mid-boom sheeting, severely angled take offs and curved tracks can impose greater loads and suitable allowances should be made for this. If at all unsure of your choice it is important to seek further advice. If you are close to the maximum boat size suggested, we would advise upgrading to a Torlon package, long car or the next size up.

BLOCKS

Mainsheet blocks end boom sheeting

Boat size 	5.5m	7m	10m	11.5m	13m	14m
Size 1 - 30mm sheave	█					
Size 2 - 35mm sheave	█					
Size 3 - 45mm sheave	█	█				
Size 4/5 - 58mm sheave	█	█	█	█		
Size 6 - 64mm sheave			█	█	█	
Size 7 - 70mm sheave				█	█	█

Spinnaker sheet / guy blocks

Boat size 	5.5m	6m	7m	10m	11.5m	13m	14m
Size 0 - 20mm sheave	█						
Size 1 - 30mm sheave	█						
Size 2 - 35mm sheave	█	█					
Size 3 - 45mm sheave	█	█	█				
Size 4/5 - 58mm sheave		█	█	█	█		
Size 6 - 64mm sheave				█	█	█	
Size 7 - 70mm sheave						█	█

Mast base / halyard blocks

Boat size 	6m	9m	10m	11.5m	13m	14m
Size 0 - 20mm sheave	█					
Size 1 - 30mm sheave	█					
Size 2 - 35mm sheave	█	█				
Size 3 - 45mm sheave	█	█	█			
Size 4/5 - 58mm sheave		█	█	█	█	
Size 6 - 64mm sheave				█	█	
Size 7 - 70mm sheave					█	█

Kicker blocks

Boat size 	6m	7m	8m	8.5m	11m	11.5m	13 m	14m
Size 0 - 20mm sheave	█							
Size 1 - 30mm sheave	█	█						
Size 2 - 35mm sheave		█	█					
Size 3 - 45mm sheave			█	█				
Size 4/5 - 58mm sheave				█	█	█		
Size 6 - 64mm sheave						█	█	
Size 7 - 70mm sheave							█	█

BOAT SIZE GUIDE

TRAVELLER SYSTEMS

TRACK SYSTEMS

Mainsheet Traveller systems

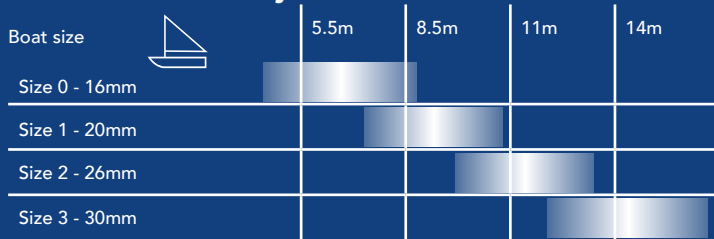

Recirculating genoa

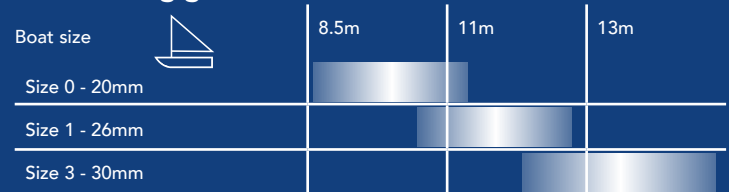

Pin stop genoa

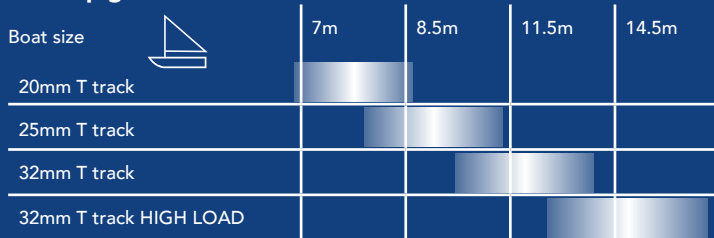

WINCH & CLUTCH

Primary genoa winch

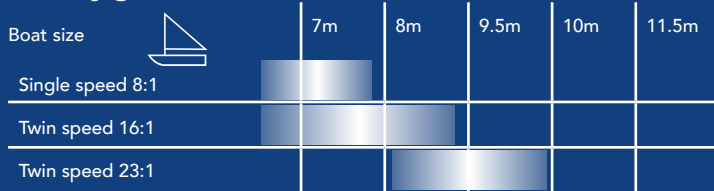

Secondary halyard winch

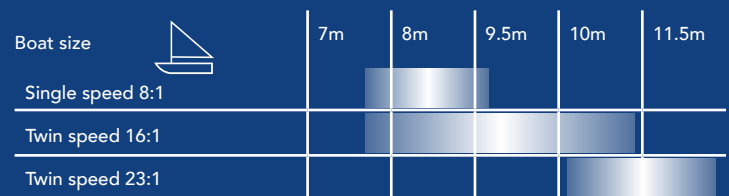

Rope clutches



BLOCK SYSTEM TRAVELLER DIAGRAMS

To see these drawings larger please visit: www.bartonmarine.com/technical-information.asp

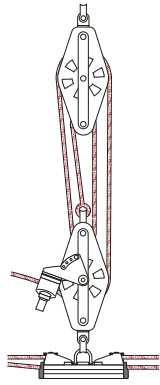

4:1 Mainsheet

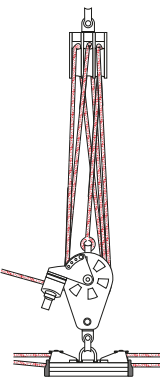

6:1 Mainsheet

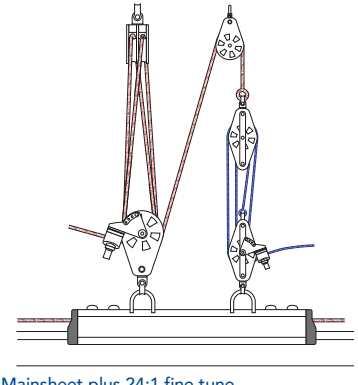

6:1 Mainsheet plus 24:1 fine tune

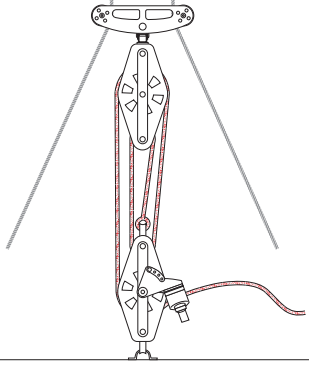

4:1 Split backstay

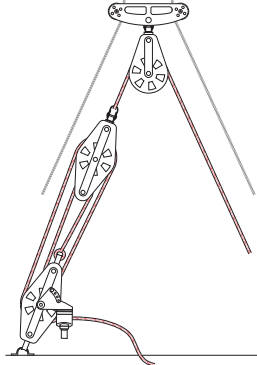

8:1 Split backstay

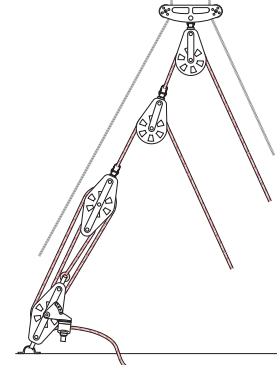

16:1 Split backstay

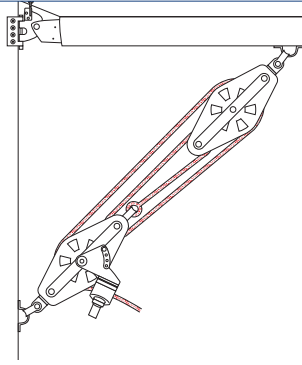

4:1 Kicker

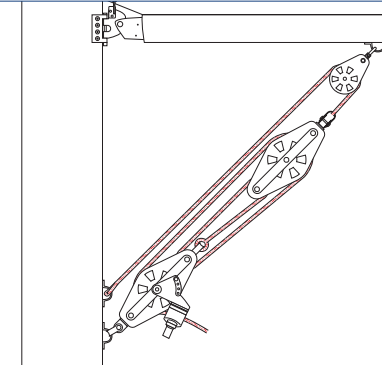

8:1 Cascaded kicker

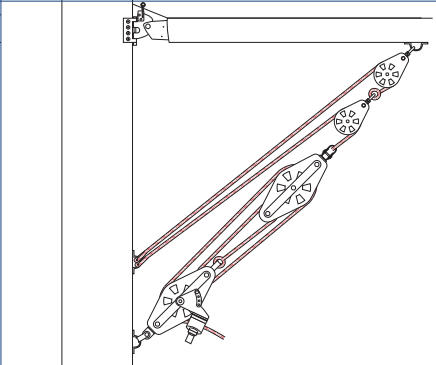

16:1 Cascaded kicker

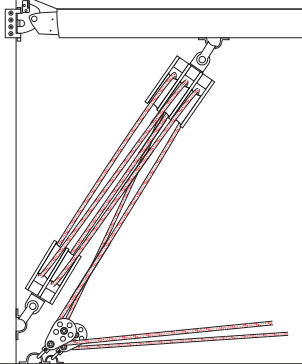

Kicker 6:1 led aft

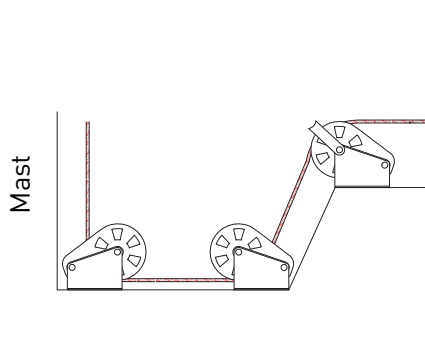

Over the top

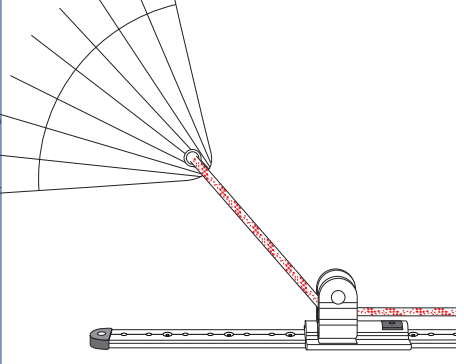

Pin stop cars

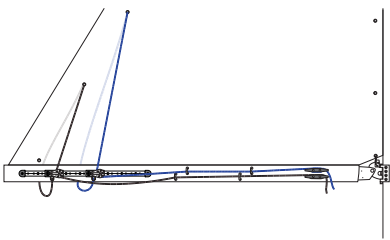

Slab reef

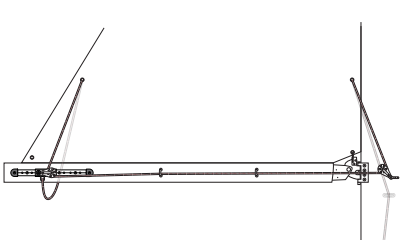

Single line reefing

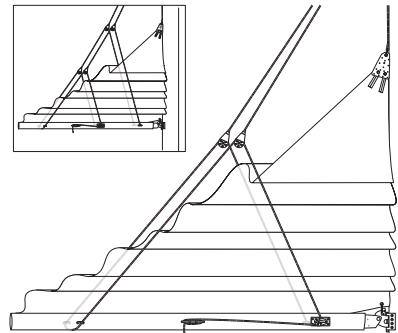

Lazy jacks

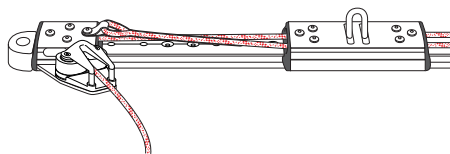

2:1 Traveller cleats on end

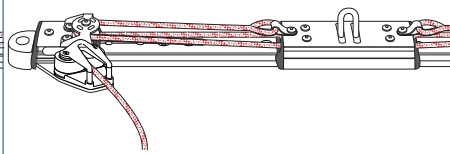

3:1 Traveller cleats on end

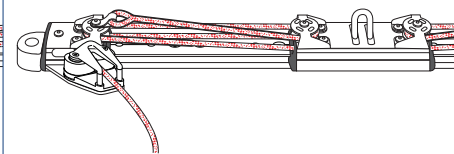

4:1 Traveller cleats on end

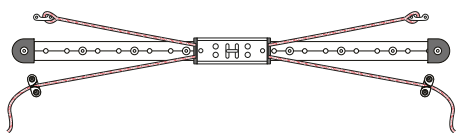

2:1 Remote cleat

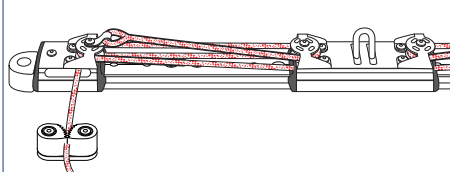

4:1 Remote cleats

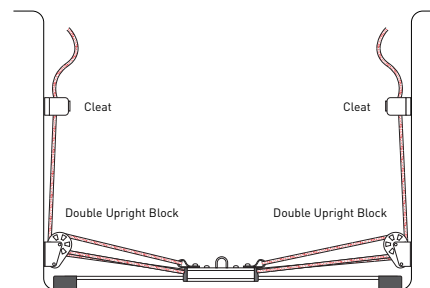

3:1 Remote cleat

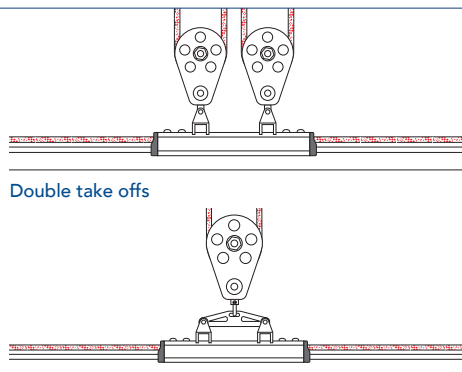

Double take offs



Link plate

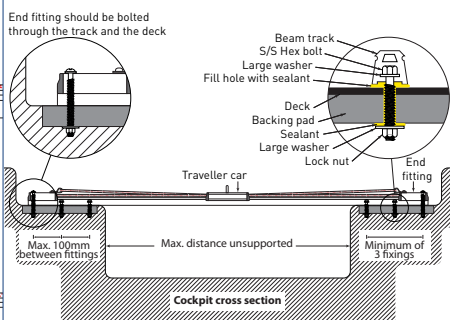

Beam track fitting

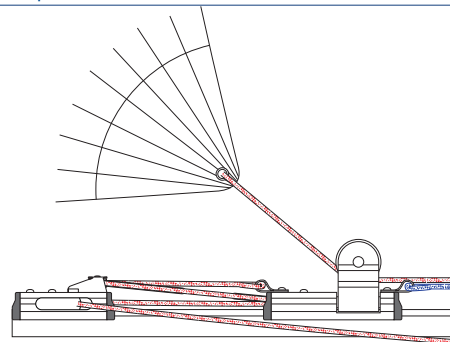

3:1 Genoa car

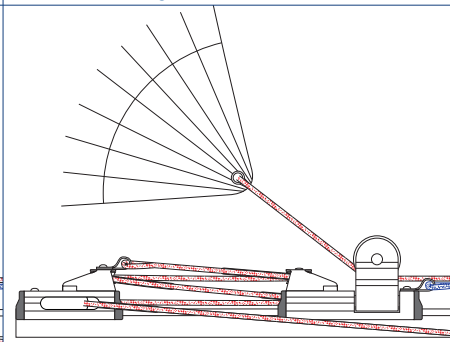

4:1 Genoa car

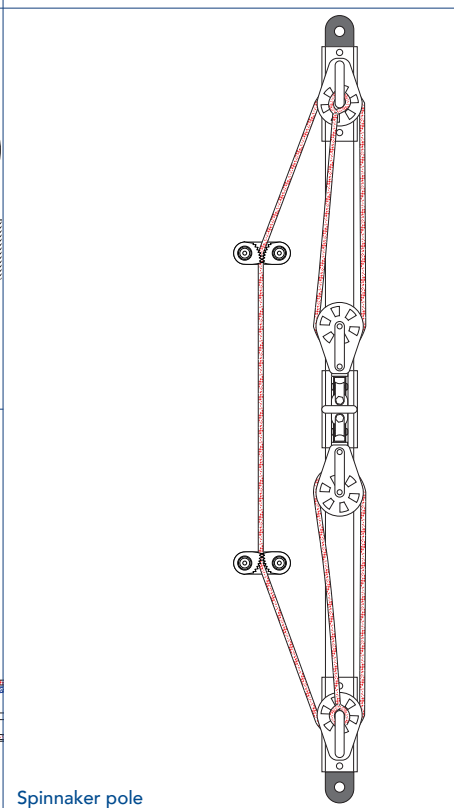

Spinnaker pole

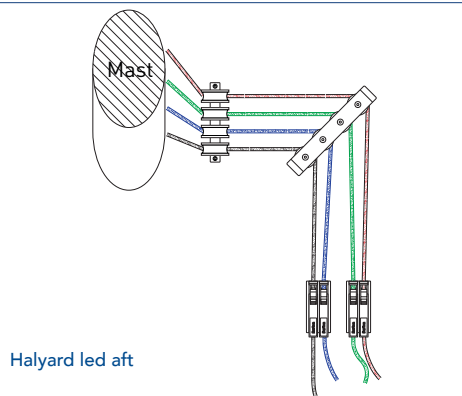

Halyard led aft

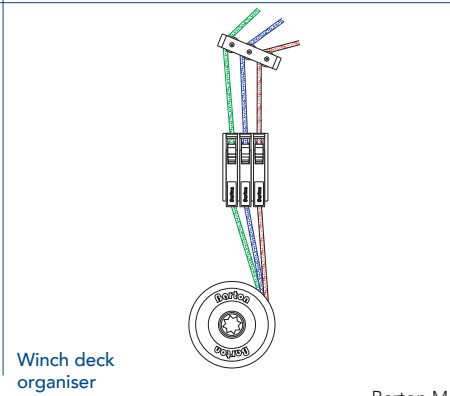

Winch deck organiser

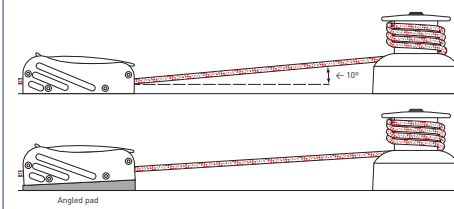

Clutch winch



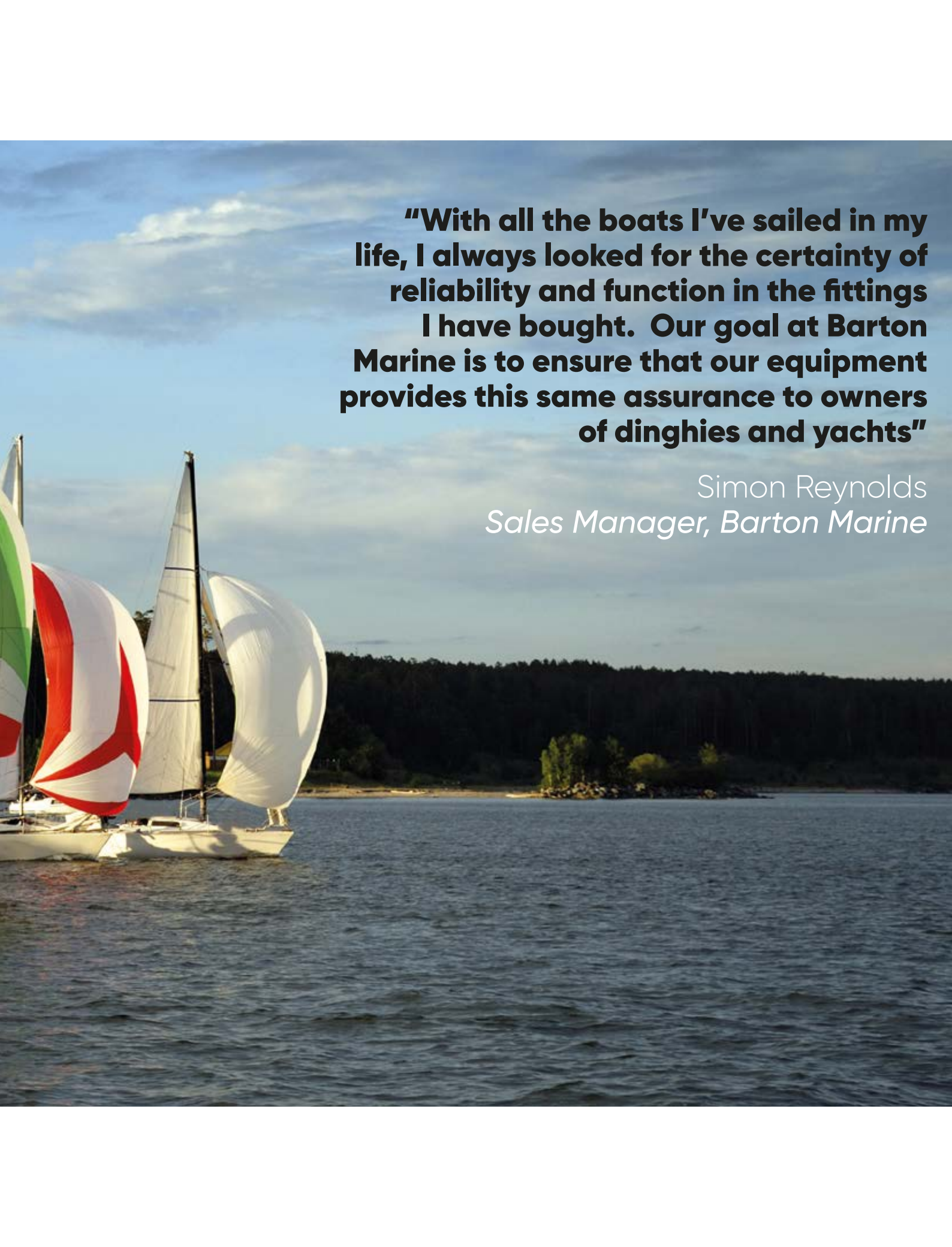



"With all the boats I've sailed in my life, I always looked for the certainty of reliability and function in the fittings I have bought. Our goal at Barton Marine is to ensure that our equipment provides this same assurance to owners of dinghies and yachts"



Simon Reynolds
Sales Manager, Barton Marine

20MM SIZE 0 BLOCKS



The 20mm sheave Size 0 block range is available in plain and ball bearing assembly. Engineered for dinghy sailors and small craft enthusiasts, the series defines high strength, keen performance and lightweight design for racing and day boats. Also ideal for lead blocks, flag pennants and small line systems on larger yachts.

1   N00110



2   N00111



3   N00130



4   N00131



5   N00160



6   N00170



7   N00190



8   N00191



Photo No.	Description	Part No.		Length (mm)	Weight (g)	
		Plain Sheave	Ball Bearing Sheave		Plain	Ball
1	Single - fixed eye	N00110	N10110	39.1	14	12
2	Single - fixed eye + becket	N00111	N10111	52.2	18	16
3	Single - swivel	N00130	N10130	53.8	21	18
4	Single - swivel + becket	N00131	N10131	66.7	25	23
5	Single - cheek block	N00160	N10160	55	16	14
6	Single - stand up	N00170	N10170	47	20	18
7	Single - swivel (without shackle)	N00190	N10190	39.6	16	13
8	Single - swivel + becket (without shackle)	N00191	N10191	52.8	20	18
9	Double - fixed eye	N00210	N10210	50.4	36	32



Sheave size 20mm x 8mm
(25/32" x 5/16")



SWL 275kg
(606lbs)



Max rolling load (ball bearing blocks)
130kg (286lbs)





Max rope diameter 5mm
(3/16")





Break load 550kg
(1210lbs)

9   N00210



10   N00230





11   N00310





12   N00311





13   N00330



14   N00331



15   N00511





16   N00931





Photo No.	Description	Part No.		Length (mm)	Weight (g)	
		Plain Sheave	Ball Bearing Sheave		Plain	Ball
	Double - fixed eye + becket	N00211	N10211	63.5	40	36
10	Double - swivel	N00230	N10230	65.8	43	38
	Double - swivel + becket	N00231	N10231	79	47	42
11	Triple - fixed eye	N00310	N10310	50.4	53	46
12	Triple - fixed eye + becket	N00311	N10311	63.5	57	50
13	Triple - swivel	N00330	N10330	66.7	60	53
14	Triple - swivel + becket	N00331	N10331	79.3	63	57
15	Triple - fixed eye + becket + cam	N00511	N10511	71.7	103	95
16	Triple - swivel + becket + cam	N00931	N10931	88.5	108	106
	Triple - swivel + cam	N00930	N10930	89	112	110

30MM SIZE 1 BLOCKS



The 30mm sheave Size 1 block range is designed with an internal steel frame for added strength and durability. Available in plain and ball bearing sheave options, the lightweight modern design is available in variations that allow for a multitude of uses on every size craft. See pages 10-11 for rigging specifications.

1   N01090





2   N01110



3   N01111





4   N01130



5   N01131



6   N01150



7   N01160



8   N01170



Photo No.	Description	Part No.		Length (mm)	Weight (g)	
		Plain Sheave	Ball Bearing Sheave		Plain	Ball
1	Single - double tang	N01090	N11090	55	47	45
	Single - double tang + becket	N01091	N11091	66	55	54
2	Single - fixed eye	N01110	N11110	55	31	32
3	Single - fixed eye + becket	N01111	N11111	66	42	40
4	Single - swivel	N01130	N11130	73	43	41
5	Single - swivel + becket	N01131	N11131	84	51	49
6	Single - upright	N01150	N11150	53	63	62
	Single - upright with fairlead	N01151	N11151	63	70	69
7	Lightweight cheek block	N01160	N11160	55	21	20
8	Single - stand up block	N01170	N11170	64	42	40
	Single - spinnaker lead	N01180	N11180	99	54	52



Sheave size 30mm x 12mm
(1 3/16" x 15/32")



SWL 355kg
(782lbs)



Max rolling load (ball bearing blocks)
245kg (540lbs)



Max rope diameter 8mm
(5/16")



Break load 710kg
(1565lbs)

9 N01190



10 N01210



11 N01230



12 N01231



13 N01280



14 N01311



15 N01330



16 N01331



Photo No.	Description	Part No.	Part No.	Length (mm)	Weight (g)	
		Plain Sheave	Ball Bearing Sheave		Plain	Ball
9	Lightweight lead block	N01190	N11190	44	19	18
10	Double - fixed eye	N01210	N11210	55	64	61
	Double - fixed eye + becket	N01211	N11211	66	72	69
11	Double - swivel	N01230	N11230	73	78	73
12	Double - swivel + becket	N01231	N11231	84	85	82
	Double - upright	N01250	N11250	53	89	84
13	Back-to-back swivel	N01280	N11280	90	68	63
14	Triple - fixed eye	N01310	N11310	54	86	80
	Triple - fixed eye + becket	N01311	N11311	63	94	88
15	Triple - swivel	N01330	N11330	73	95	89
16	Triple - swivel + becket	N01331	N11331	84	104	98

35MM SIZE 2 BLOCKS

The 35mm sheave Size 2 block range provides high performance and load values in a variety of assemblies. The range has an internal stainless steel frame and precision components with plain or ball bearing sheave options. The lightweight design makes this range perfect for a multitude of uses on every yacht. See pages 10-11 for rigging specifications.



1  
N02110



2  
N02130



3  
N02131



4  
N02141



5  
N02160



6  
N02170



7  
N02210



8  
N02230



9  
N02231

Photo No.	Description	Part No.		Length (mm)	Weight (g)	
		Plain Sheave	Ball Bearing Sheave		Plain	Ball
	Single - double tang	N02090	N12090	65	52	51
	Single - double tang + becket	N02091	N12091	76	61	59
1	Single - fixed eye	N02110	N12110	65	40	39
	Single - fixed eye + becket	N02111	N12111	76	49	48
2	Single - swivel	N02130	N12130	80	49	47
3	Single - swivel + becket	N02131	N12131	91	56	55
4	Single - snap shackle	N02140	N12140	91	84	82
	Single - snap shackle + becket	N02141	N12141	100	92	91
	Single - upright	N02150	N12150	51	79	78
	Single - upright with fairlead	N02151	N12151	75	88	87
5	Single - cheek block with back plate	N02160	N12160	80	72	71
	Curved backing plate (for cheek block)	N02161	-	80	14	14
6	Single - stand up	N02170	N12170	92	126	123
	Single - stand up + becket	N02171	N12171	103	135	132
	Single - spinnaker lead	N02180	N12180	107	64	62
	Single - stanchion lead	N02190	N12190	95	71	69
7	Double - fixed eye	N02210	N12210	65	75	73
	Double - fixed eye + becket	N02211	N12211	76	83	81
8	Double - swivel	N02230	N12230	80	86	84
9	Double - swivel and becket	N02231	N12231	91	97	94



Sheave size 35mm x 11mm (1 3/8" x 15/32")
Fiddle 30/45mm x 11mm (1 3/16" / 1 3/4" x 15/32")



Max rolling load (ball bearing blocks)
260kg (573lbs)



Max rope diameter 8mm
(5/16")



SWL 370kg
(815lbs)



Break load 740kg
(1630lbs)

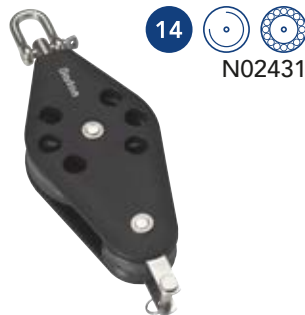

Photo No.	Description	Part No.	Part No.	Length (mm)	Weight (g)	Weight (g)
		Plain Sheave	Ball Bearing Sheave		Plain	Ball
	Double - upright	N02250	N12250	63	110	108
	Back-to-back swivel	N02280	N12280	100	77	75
	Double - stanchion lead	N02290	N12290	95	108	106
10	Triple - fixed eye	N02310	N12310	76	100	95
	Triple - fixed eye + becket	N02311	N12311	85	109	106
11	Triple - swivel	N02330	N12330	80	108	106
	Triple - swivel + becket	N02331	N12331	91	119	114
12	Fiddle - fixed eye	N02410	N12410	113	89	88
	Fiddle - fixed eye + becket	N02411	N12411	124	96	96
13	Fiddle - swivel	N02430	N12430	134	99	98
14	Fiddle - swivel + becket	N02431	N12431	145	106	106
	Fiddle - snap shackle	N02440	N12440	142	133	133
	Fiddle - snap shackle + becket	N02441	N12441	152	140	139
15	Single - swivel + becket + cam	N02531	N12531	100	107	107
	Single - snap shackle + becket + cam	N02541	N12541	110	192	190
	Single - stand up + becket + cam	N02571	N12571	120	206	208
16	Fiddle - swivel + becket + cam	N02631	N12631	145	160	159
17	Fiddle - snap shackle + becket + cam	N02641	N12641	150	196	195
18	Fiddle - swivel + becket + plastic cam	N02731	N12731	145	161	161

45MM SIZE 3 BLOCKS

The 45mm sheave size 3 block range incorporates modern design with stainless steel frames and the latest advanced materials, using 30% fibre glass filled nylon and Acetal sheaves to maximise their strength whilst keeping weight to a minimum. Suitable for use as mainsheet, vang, lead blocks or wherever a powerful and compact purchase system is required on dinghies, dayboats and lightweight cruisers. See pages 10-11 for rigging specifications.

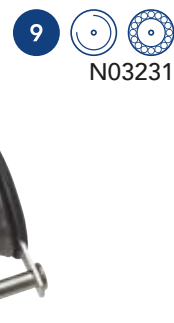

Photo No.	Description	Part No.	Part No.	Length (mm)	Weight (g)	
		Plain Sheave	Ball Bearing Sheave		Plain	Ball
	Single - double tang	N03090	N13090	80	74	77
	Single - double tang + becket	N03091	N13091	91	80	85
1	Single - fixed eye	N03110	N13110	80	61	65
	Single - fixed eye + becket	N03111	N13111	91	70	74
2	Single - swivel	N03130	N13130	100	79	82
3	Single - swivel + becket	N03131	N13131	111	86	91
	Single - snap shackle	N03140	N13140	109	106	108
4	Single - snap shackle + becket	N03141	N13141	120	115	118
	Single - upright	N03150	N13150	75	121	124
	Single - upright with fairlead	N03151	N13151	85	130	133
5	Single - cheek block with back plate	N03160	N13160	92	106	109
	Curved backing plate (for cheek block)	N03161	-	92	18	18
6	Single - stand up	N03170	N13170	108	146	151
	Single - stand up + becket	N03171	N13171	119	155	158
	Single - stanchion lead	N03190	N13190	110	92	96
7	Double - fixed eye	N03210	N13210	80	111	117
	Double - fixed eye + becket	N03211	N13211	92	119	126
8	Double - swivel	N03230	N13230	100	131	138
9	Double - swivel and becket	N03231	N13231	111	140	148



Sheave size 45mm x 13mm (1 3/4" x 35/64")
Fiddle 30/58mm x 13mm (1 3/16" / 2 1/4" x 35/64")



Max rolling load (ball bearing blocks)
270kg (595lbs)



Max rope diameter 10mm
(5/16")



SWL 400kg
(881lbs)



Break load 800kg
(1763lbs)

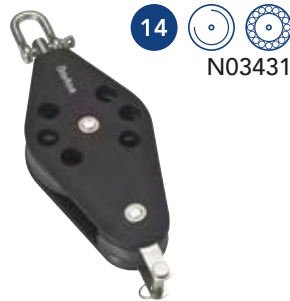

Photo No.	Description	Part No.		Length (mm)	Weight (g)	
		Plain Sheave	Ball Bearing Sheave		Plain	Ball
	Double - upright	N03250	N13250	75	168	175
10	Triple - fixed eye	N03310	N13310	80	151	161
	Triple - fixed eye + becket	N03311	N13311	91	159	167
11	Triple - swivel	N03330	N13330	100	168	179
	Triple - swivel + becket	N03331	N13331	111	172	187
12	Fiddle - fixed eye	N03410	N13410	133	128	134
	Fiddle - fixed eye + becket	N03411	N13411	144	136	142
13	Fiddle - swivel	N03430	N13430	150	142	151
14	Fiddle - swivel + becket	N03431	N13431	158	153	151
	Fiddle - snap shackle	N03440	N13440	161	171	170
	Fiddle - snap shackle + becket	N03441	N13441	172	179	178
15	Single - swivel + becket + cam	N03511	N13511	115	172	173
	Triple - swivel + becket + cam	N03531	N13531	115	264	276
	Single - snap shackle + becket + cam	N03541	N13541	120	188	191
	Single - stand up + becket + cam	N03571	N13571	135	238	241
16	Fiddle - swivel + becket + cam	N03631	N13631	165	241	247
	Fiddle - swivel + cam	N03630	N13360	165	236	341
17	Fiddle - snap shackle + becket + cam	N03641	N13641	170	265	273
18	Fiddle - swivel + becket + plastic cam	N03731	N13731	165	242	251

54MM SIZE 4/5 BLOCKS

The 54mm sheave Size 4/5 range is of a rugged construction, featuring high grade moulded side plates that are through-bolted and riveted for added strength and security. All load carrying components and interior frame are from marine grade 316 stainless steel and both plain and ball bearing sheaves are available. This sleek and versatile range is engineered for use on larger cruising and racing yachts and is compatible with our ball bearing mainsheet traveller system.



1  
N05090



2  
N05110



3  
N05120



4  
N05130



5  
N05140



6  
N05170



7  
N05180



8  
N05220



9  
N05320

Photo No.	Description	Part No.		Length (mm)	Weight (g)	
		Plain Sheave	Ball Bearing Sheave		Plain	Ball
	Single - upright	N04150	N14150	92	215	212
	Single - upright with fairlead	N04151	N14151	105	231	231
	Single - cheek block with backing plate	N04160	N14160	107	191	187
	Double - upright	N04250	N14250	92	318	311
1	Single - double tang	N05090	N15090	114	158	151
	Single - double tang + becket	N05091	N15091	137	185	174
2	Single - fixed eye	N05110	N15110	107	151	140
	Single - fixed eye + becket	N05111	N15111	130	173	164
3	Single - reverse shackle	N05120	N15120	130	173	161
	Single - reverse shackle + becket	N05121	N15121	150	197	185
4	Single - swivel	N05130	N15130	130	193	182
	Single - swivel + becket	N05131	N15131	153	220	205
5	Single - snap shackle	N05140	N15140	142	255	241
	Single - snap shackle + becket	N05141	N15141	165	286	265
6	Single - stand up	N05170	N15170	140	347	329
	Single - stand up + becket	N05171	N15171	163	370	352
7	Single - varilock	N05180	N15180	125	196	181
	Single - varilock + becket	N05181	N15181	148	220	205
	Single - stanchion lead	N05190	N15190	135	182	168
	Double - fixed eye	N05210	N15210	121	274	247
	Double - fixed eye + becket	N05211	N15211	125	274	247
8	Double - reverse shackle	N05220	N15220	125	268	244
	Double - reverse shackle + becket	N05221	N15221	147	290	268
	Double - swivel	N05230	N15230	130	290	266
	Double - swivel + becket	N05231	N15231	141	312	289



Single 54mm x 17mm (2 1/8" x 5/8")
Fiddle 38/64mm x 17mm (1 1/2" / 2 1/2" x 5/8")



Max rolling load (ball bearing blocks)
525kg (1157lbs)



Max rope diameter 12mm
(7/16")



SWL 750kg
(1650lbs)



Break load 1500kg
(3300lbs)



10  
N05330



10  
N05420



12  
N05430



13  
N05440



14  
N05480



15  
N05631



16  
N05641



17  
N05681



18  
N05930

Photo No.	Description	Part No.		Length (mm)	Weight (g)	
		Plain Sheave	Ball Bearing Sheave		Plain	Ball
9	Triple - reverse shackle	N05320	N15320	130	371	334
	Triple - reverse shackle + becket	N05321	N15321	148	391	355
10	Triple - swivel	N05330	N15330	150	388	346
	Triple - swivel + becket	N05331	N15331	173	408	375
	Fiddle - fixed eye	N05410	N15410	183	251	255
	Fiddle - fixed eye + becket	N05411	N15411	209	318	296
	11	Fiddle - reverse shackle	N05420	N15420	185	271
	Fiddle - reverse shackle + becket	N05421	N15421	205	300	285
12	Fiddle - swivel	N05430	N15430	185	289	273
	Fiddle - swivel + becket	N05431	N15431	209	310	293
13	Fiddle - snap shackle	N05440	N15440	200	362	335
	Fiddle - snap shackle + becket	N05441	N15441	220	378	360
14	Fiddle - variloc	N05480	N15480	185	295	275
	Fiddle - variloc + becket	N05481	N15481	209	313	276
	Single - swivel + becket + cam	N05531	N15531	153	398	206
	Single - snap shackle + becket + cam	N05541	N15541	165	286	272
	Single - stand up + becket + cam	N05571	N15571	163	370	352
15	Fiddle - swivel + becket + cam	N05631	N15631	209	493	480
16	Fiddle - snap shackle + becket + cam	N05641	N15641	215	568	542
17	Fiddle - variloc + cam	N05680	N15680	205	508	-
	Fiddle - variloc + becket + cam	N05681	N15681	209	496	479
	Fiddle - swivel + becket + plastic cam	N05731	N15731	209	318	296
18	Triple - swivel + cam	N05930	N15930	150	660	645
	Triple - swivel + becket + cam	N05931	N15931	173	614	578

64MM SIZE 6 BLOCKS

The 64mm sheave Size 6 high load cruiser block range is of rugged construction, featuring high grade injection moulded side plates, with all load carrying components from 316 grade stainless steel. Side plates are through-bolted and riveted for added strength and security. This good looking and versatile range is designed for use on larger cruising and racing yachts. All are designed for ease of use with our ball bearing mainsheet traveller system. See page 10-11 for rigging specifications.



1  
N06090



2  
N06110



3  
N06120



4  
N06130



5  
N06140



6  
N06170



7  
N06180



8  
N06220



9  
N06320

Photo No.	Description	Part No.		Length (mm)	Weight (g)	
		Plain Sheave	Ball Bearing Sheave		Plain	Ball
1	Single - double tang	N06090	N16090	126	186	186
2	Single - fixed eye	N06110	N16110	118	177	173
	Single - fixed eye + becket	N06111	N16111	147	205	197
3	Single - reverse shackle	N06120	N16120	140	201	193
	Single - reverse shackle + becket	N06121	N16121	165	229	225
4	Single - swivel	N06130	N16130	142	219	216
	Single - swivel + becket	N06131	N16131	167	247	242
5	Single - snap shackle	N06140	N16140	170	292	283
	Single - snap shackle + becket	N06141	N16141	180	322	307
6	Single - stand up	N06170	N16170	150	369	361
	Single - stand up + becket	N06171	N16171	179	399	391
7	Single - variloc	N06180	N16180	138	218	214
	Single - variloc + becket	N06181	N16181	165	254	244
8	Double - reverse shackle	N06220	N16220	135	319	304
	Double - reverse shackle + becket	N06221	N16221	164	343	333
9	Triple - reverse shackle	N06320	N16320	135	446	421
	Triple - reverse shackle + becket	N06321	N16321	167	465	451



Single 64mm x 18mm (2 1/2" x 45/64")
Fiddle 44/72mm x 18mm (1 3/4" / 2 53/64" x 45/64")



Max rolling load (ball bearing blocks)
700kg (1543lbs)



Max rope diameter 12mm
(7/16")



SWL 1000kg
(2200lbs)



Break load 2000kg
(4400lbs)



10  
N06330

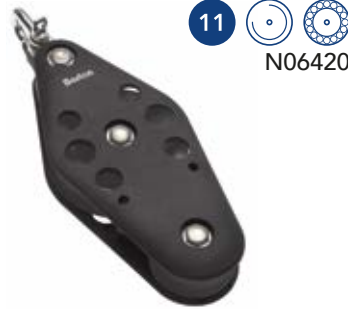

11  
N06420



12  
N06430



13  
N06440



14  
N06480



15  
N06630



16  
N06640



17  
N06680



18  
N06930

Photo No.	Description	Part No.		Length (mm)	Weight (g)	
		Plain Sheave	Ball Bearing Sheave		Plain	Ball
10	Triple - swivel	N06330	N16330	170	458	439
	Triple - swivel + becket	N06331	N16331	193	481	461
11	Fiddle - reverse shackle	N06420	N16420	210	339	321
	Fiddle - reverse shackle + becket	N06421	N16421	233	366	350
12	Fiddle - swivel	N06430	N16430	210	372	357
	Fiddle - swivel + becket	N06431	N16431	235	400	392
13	Fiddle - snap shackle	N06440	N16440	220	417	407
	Fiddle - snap shackle + becket	N06441	N16441	250	450	437
14	Fiddle - variloc	N06480	N16480	205	356	335
	Fiddle - variloc + becket	N06481	N16481	232	383	362
15	Fiddle - swivel + becket + cam	N06631	N16631	232	588	554
16	Fiddle - snap shackle + becket + cam	N06641	N16641	245	639	618
17	Fiddle - variloc + becket + cam	N06681	N16681	235	575	557
18	Triple - swivel + cam	N06930	N16930	170	672	645
	Triple - swivel + becket + cam	N06931	N16931	193	696	671

70MM SIZE 7 BLOCKS

The 70mm sheave Size 7 high load cruising block range is engineered for superior strength and performance and offers both plain and ball bearing sheave assemblies. The range features high grade glass fibre nylon reinforced moulded side plates with internal 316 stainless steel frame that is through-bolted and riveted for added strength and durability. This well designed and versatile range is engineered for use on larger cruising and racing yachts and is compatible with our ball bearing mainsheet traveller system. See pages 10-11 for rigging specifications.



1  
N07090



2  
N07110



3  
N07120



4  
N07130



5  
N07140



6  
N07170



7  
N07180



8  
N07220



9  
N07320

Photo No.	Description	Part No.		Length (mm)	Weight (g)	
		Plain Sheave	Ball Bearing Sheave		Plain	Ball
1	Single - double tang	N07090	N17090	150	276	278
2	Single - fixed eye	N07110	N17110	137	255	253
	Single - fixed eye + becket	N07111	N17111	166	298	296
3	Single - reverse shackle	N07120	N17120	168	311	309
	Single - reverse shackle + becket	N07121	N17121	195	354	351
4	Single - swivel	N07130	N17130	163	364	348
	Single - swivel + becket	N07131	N17131	197	394	391
5	Single - snap shackle	N07140	N17140	168	359	350
	Single - snap shackle + becket	N07141	N17141	200	394	385
6	Single - stand up	N07170	N17170	162	444	444
	Single - stand up + becket	N07171	N17171	191	480	471
7	Single - variloc	N07180	N17180	163	328	324
	Single - variloc + becket	N07181	N17181	192	364	348
8	Double - reverse shackle	N07220	N17220	160	461	456
	Double - reverse shackle + becket	N07221	N17221	195	509	503
9	Triple - reverse shackle	N07320	N17320	165	616	615
	Triple - reverse shackle + becket	N07321	N17321	199	659	637



Single 72mm x 20mm (2 53/64" x 3/4")
Fiddle 44/72mm x 20mm (1 3/4" / 2 53/64" x 3/4")



Max rolling load (ball bearing blocks)
875kg (1929lbs)



Max rope diameter 14mm
(9/16")



SWL 1250kg
(2750lbs)



Break load 2500kg
(5500lbs)



Photo No.	Description	Part No.		Length (mm)	Weight (g)	
		Plain Sheave	Ball Bearing Sheave		Plain	Ball
10	Triple - swivel	N07330	N17330	163	635	725
	Triple - swivel + becket	N07331	N17331	192	678	671
11	Fiddle - reverse shackle	N07420	N17420	220	411	390
	Fiddle - reverse shackle + becket	N07421	N17421	252	428	428
12	Fiddle - swivel	N07430	N17430	220	469	435
	Fiddle - swivel + becket	N07431	N17431	248	470	470
13	Fiddle - snap shackle	N07440	N17440	222	453	439
	Fiddle - snap shackle + becket	N07441	N17441	253	488	471
14	Fiddle - variloc	N07480	N17480	220	417	405
	Fiddle - variloc + becket	N07481	N17481	249	439	430
15	Fiddle - swivel + becket + cam	N07631	N17631	248	660	654
16	Fiddle - snap shackle + becket + cam	N07641	N17641	250	670	653
17	Fiddle - variloc + becket + cam	N07681	N17681	245	637	628
18	Triple - swivel + cam	N07930	N17930	163	841	844
	Triple - swivel + becket + cam	N07931	N17931	192	886	797

TRADITIONAL BARTON RANGE

Traditional Barton Block Range

The Traditional Range of Barton Blocks stands the test of time and echoes the engineering superiority that define Barton's standards: Performance, Endurance, Quality and Value.

For those who require continuity of range, we still manufacture size 1 to 7 in the traditional design and construction that sailors have depended on for decades. The line maintains glass fibre mouldings with Acetal sheave construction for plain and ball bearing assemblies, finished with marine grade stainless steel shackles and components.

Specifications for the full range of Traditional Blocks can be found online at www.bartonmarine.com





Specifications for the full range of Traditional Blocks can be found online at www.bartonmarine.com

CLASSIC WOODEN BLOCKS

VICTORY COLLECTION

Crafted by sailors for sailors, the Victory blocks are manufactured in the UK from traditional ash wood, with a high gloss marine varnish finish. Victory blocks are bolted together and can be unfastened for servicing and re-finishing.

The Victory collection of wooden blocks not only look good, but are highly durable and designed to withstand many years of use in harsh marine environments. The sleek wooden plates conceal the modern technical working of Barton's proven high performance engineering, with Delrin ball bearings, Torlon needle bearings, gun metal coloured sheave and solid brass fittings.



1 
50030

 Sheave size 30 x 12mm
(1 3/16 x 15/32")

 Max rope diameter
8mm (5/16")

 Break Load
700kg (1543lbs)

 Max rolling load
245kg (540lbs)





2 
52030



4 
50045

 Sheave size 45 x 14mm
(1 3/4 x 35/64")

 Max rope diameter
10mm (3/8")

 Break Load
700kg (1543lbs)

 Max rolling load
270kg (595lbs)





3 
53245



5 
50060

 Sheave size 60 x 18mm
(2 1/2 x 45/64")

 Max rope diameter
12mm (7/16")

 Break Load
1400kg (3086lbs)



 Max rolling load
700kg (1543lbs)





Photo No.	Description	Part No.	Bearing	Length (mm)	Weight (g)	SWL (kg)	Break Load (kg)
1	30mm Single - fixed eye	50030	Delrin balls	70	46	350	700
	30mm Single - fixed eye + becket	50230	Delrin balls	90	54	350	700
	30mm Single - swivel	50330	Delrin balls	88	71	350	700
	30mm Single - swivel + becket	50430	Delrin balls	109	79	350	700
2	30mm Double - fixed eye	52030	Delrin balls	70	67	350	700
	30mm Double - fixed eye + becket	52230	Delrin balls	90	75	350	700
	30mm Double - swivel	52330	Delrin balls	88	92	350	700
	30mm Double - swivel + becket	52430	Delrin balls	109	100	350	700
	30mm Triple - fixed eye	53030	Delrin balls	70	90	350	700
	30mm Triple - fixed eye + becket	53230	Delrin balls	90	96	350	700
	30mm Triple - swivel	53330	Delrin balls	88	115	350	700
	30mm Triple - swivel + becket	53430	Delrin balls	109	121	350	700
4	45mm Single - fixed eye	50045	Delrin balls	90	85	350	700
	45mm Single - fixed eye + becket	50245	Delrin balls	111	97	350	700

Combining high performance engineering and classic design, our range of wooden blocks has been designed for mariners who appreciate elegance and want technical excellence. The range has been named in honour of the flagship of the Royal Navy - the HMS Victory.

6  50080

7  Fastener Tool - 50010



-  Sheave size 80 x 20mm (3 3/8 x 3/4")
-  Max rope diameter 14mm (35/64")
-  Break Load 2500kg (5511lbs)
-  Max rolling load 1200kg (2645lbs)

Torlon Needle Bearing Interior

Photo No.	Description	Part No.	Bearing	Length (mm)	Weight (g)	SWL (kg)	Break Load (kg)
	45mm Single - swivel	50345	Delrin balls	105	107	350	700
	45mm Single - swivel + becket	50445	Delrin balls	127	119	350	700
	45mm Double - fixed eye	52045	Delrin balls	90	139	350	700
	45mm Double - fixed eye + becket	52245	Delrin balls	111	151	350	700
	45mm Double - swivel	52345	Delrin balls	105	159	350	700
	45mm Double - swivel + becket	52445	Delrin balls	127	171	350	700
	45mm Triple - fixed eye	53045	Delrin balls	90	189	350	700
3	45mm Triple - fixed eye + becket	53245	Delrin balls	111	201	350	700
	45mm Triple - swivel	53345	Delrin balls	105	208	350	700
	45mm Triple - swivel + becket	53445	Delrin balls	127	220	350	700
5	60mm Single - fixed eye	50060	Delrin balls	120	190	700	1400
6	80mm Single - fixed eye	50080	Torlon needle roller with Delrin ball side bearings	140	530	1250	2500
7	Fastener tool	50010	Wood block hand tool	-	-	-	-

SNATCH BLOCKS

Two sizes - accepting lines up to 16mm ø (5/8")

Our popular range of snatch blocks - of rugged construction with an easy open/close action. The range features a choice of D shackle or snap shackles.

Small Snatch blocks

Unique to Barton, these blocks are probably the smallest block of this type available.

Extremely compact and strong, with a multitude of uses on cruising or racing yachts where a large unit is not required.

Available with stainless steel snap shackle or D shackle.



Photo No.	Description	Part No.	Sheave ø (mm)	Sheave Width (mm)	Rope ø (mm)	Break Load (kg)	SWL (kg)	Length (mm)	Weight (g)
1	Small snatch block + S/S snap	90301	35	17	12	800	400	110	170
2	Snatch block + S/S snap	90401	48	20	16	1100	550	150	378
3	Snatch block + S/S 'D' shackle	90402	48	20	16	1300	650	144	316

Bronze snap shackles

A range of 4 bronze snap shackles. Available in plain bronze for a classic appearance or chrome plated. All versions have tapped holes so the shackles can be attached to any equipment as required by the customer

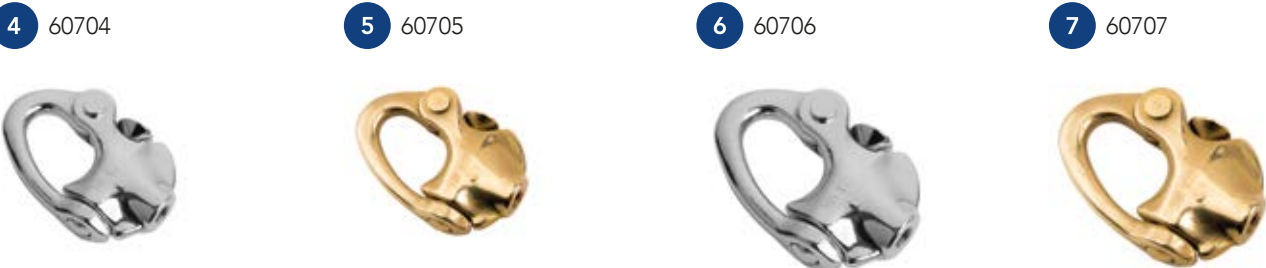

Photo No.	Description	Part No.	Shackle size (mm)	Overall length (mm)	Thread size	Break Load (kg)	SWL (kg)	Weight (g)
4	Chrome plated bronze	60704	25	56	M6	500	250	7.5
5	Bronze	60705	25	56	M6	500	250	7.5
6	Chrome plated bronze	60706	27	67	M8	900	450	14.5
7	Bronze	60707	27	67	M8	900	450	14.5

STAINLESS STEEL BLOCKS

30/35/45mm STAINLESS STEEL BLOCKS

For lines up to 10mm diameter. Available with plain or ball bearing sheaves.

A robust range of stainless steel blocks with a multitude of uses on all types of sailing boats.

Highly polished side plates with flared cheeks prevent the possibility of chafing the line whilst giving added strength.

These are ideal for use on dinghies and dayboats for kicking straps or wherever a compact and powerful rope tackle is required.





1  
95100
95200
95300



2  
95102
95202
95302



3  
95104
95204
95304



4  
95105
95205
95305





5  
95120
95220
95320





6  
95121
95221
95321



7  
95122
95222
95322



8  
95123
95223
95323



9  
95130
95230
95330



10  
95137
95237
95337



11  
95138
95238
95338

Specifications







	Size 1	Size 2	Size 3
 Sheave ø	30mm	35mm	45mm
 Sheave width	11mm	11mm	13mm
 Max rope ø	8mm	8mm	10mm
 Break load	560kg	800kg	800kg
 SWL	280kg	400kg	400kg
 Max rolling load (ball bearing blocks)	200kg	280kg	280kg

Photo No.	Description	Part No.		Length (mm)	Weight (g)	
		Plain Sheave	Ball Bearing Sheave		Plain	Ball
Size 1 s/s blocks						
1	Single	95100	95400	50	34	32
	Single + becket	95101	95401	67	45	43
2	Single - fixed eye	95102	95402	68	39	37
	Single - fixed eye + becket	95103	95403	85	48	46
3	Single - swivel	95104	95404	86	53	51
4	Single - swivel + becket	95105	95405	100	63	61
5	Double - fixed eye	95120	95420	68	60	54
6	Double - fixed eye + becket	95121	95421	85	70	66
7	Double - swivel	95122	95422	83	76	72
8	Double - swivel + becket	95123	95423	100	86	82
9	Triple - fixed eye	95130	95430	68	82	76
10	Triple - fixed eye + becket	95137	95437	85	93	87
11	Triple - swivel	95138	95438	83	99	93
	Triple - swivel + becket	95139	95439	100	109	103
Size 2 s/s blocks						
1	Single	95200	95500	61	45	45
	Single + becket	95201	95501	84	60	60
2	Single - fixed eye	95202	95502	76	48	48
	Single - fixed eye + becket	95203	95503	99	63	63
3	Single - swivel	95204	95504	96	63	63
4	Single - swivel + becket	95205	95505	119	79	79
5	Double - fixed eye	95220	95520	76	77	77
6	Double - fixed eye + becket	95221	95521	98	92	92
7	Double - swivel	95222	95522	95	92	92
8	Double - swivel + becket	95223	95523	116	107	107
9	Triple - fixed eye	95230	95530	75	105	105
10	Triple - fixed eye + becket	95231	95531	97	120	120
11	Triple - swivel	95232	95532	97	121	121
	Triple - swivel + becket	95233	95533	117	136	136
Size 3 s/s blocks						
1	Single	95300	95600	80	61	64
	Single + becket	95301	95601	112	80	83
2	Single - fixed eye	95302	95602	93	71	74
	Single - fixed eye + becket	95303	95603	124	94	97
3	Single - swivel	95304	95604	107	87	90
4	Single - swivel + becket	95305	95605	139	107	110
5	Double - fixed eye	95320	95620	93	112	118
6	Double - fixed eye + becket	95321	95621	124	136	142
7	Double - swivel	95322	95622	107	129	135
8	Double - swivel + becket	95323	95623	139	149	155
9	Triple - fixed eye	95330	95630	93	153	162
10	Triple - fixed eye + becket	95331	95631	124	185	194
11	Triple - swivel	95332	95632	167	135	144
	Triple - swivel + becket	95333	95633	139	167	176

INDUSTRIAL BLOCKS & BLOCK ON A STROP

INDUSTRIAL BLOCKS

Industrial snatch blocks are designed for easy use in commercial, industrial or marine settings to move or lift loads securely.

These durable snatch blocks are made of 316 stainless steel with anodised aluminium sheaves and are CE certified and stamped. The Industrial Range handles rope or wire thicknesses of 8 to 14 mm – and a special design that handles 32mm line. Snatch blocks are easy to load and instantly mobile for diverse projects used for:

- Construction sites / manufacturing sites
- Commercial marine environments
- Rigging projects
- Agricultural, building repairs, home improvements
- Entertainment venues
- Lift and pulling applications
- CE certified and stamped



Size	Product No.	WWL (kg)
30mm sheave	92030	75
50mm sheave	92050	125
75mm sheave	92075	275
100mm sheave	92100	375
70mm sheave	92135	225

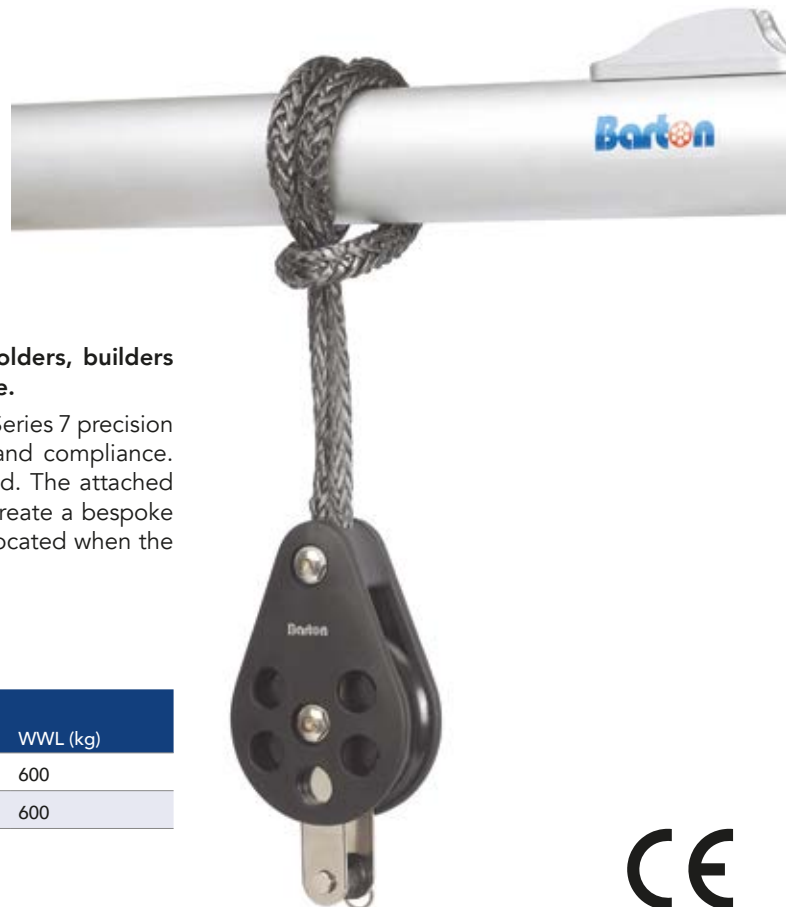

BLOCK ON A STROP

This special block was designed and developed for marinas, scaffolders, builders and any engineer who needs multiple lift options at a given worksite.

Manufactured of black glass filled nylon and stainless steel, this durable Series 7 precision plain or ball bearing sheave block is CE certified for secure quality and compliance. The stainless steel becket at the base provides leverage when required. The attached Dyneema spliced strop can be slipped around a pole, tube or bar to create a bespoke lifting device for tools, equipment or panels - and then removed or relocated when the job is complete.

Size	Product No.	WWL (kg)
Block on a strop - plain sheave	N07191	600
Block on a strop - ball bearing sheave	N17191	600



WIRE ROPE BLOCKS

Backstay tensioner blocks

Featuring laser-cut stainless steel side plates with precision turned brass sheaves. For use on twin or split backstays - for backstay wire of up to 10mm Ø (see page 12 for setup options).

Backstay tensioner system

A block and tackle system designed for use on split or twin backstays. Features stainless steel double block with brass sheaves, together with tensioning blocks from our series 2 range (see page 12 for setup options).

High load wire rope blocks

Available in fixed eye or swivel head. Cheeks are manufactured from 316 stainless steel and sheaves are precision turned from solid brass bar, running on a stainless steel centre bush.

Upright blocks

With heavy duty 316 stainless steel side plates. Sheaves are precision turned from solid aluminium bar, silver anodised and running on nylon bearings to reduce friction under load.

Upright block dimensions

91400 Base 38 x 45mm
Fastenings 5mm

91500 Base 51 x 55mm
Fastenings 6mm

Aluminium high load blocks

A range of high strength blocks designed for use with wire ropes or exceptionally rugged applications.

Cheeks are manufactured from marine grade aluminium, grey anodised for high UV-resistance and durability.

Sheaves are precision turned from solid aluminium bar, silver anodised and running on nylon bearings to reduce friction under load.

Reinforcing plates, rivets, shackles and straps are all from 316 stainless steel.

Cheek block dimensions

91650 Base 103 x 53mm
Fastenings 5mm

91750 Base 120 x 65mm
Fastenings 6mm

Brass sheave blocks

A simple lead block with turned brass sheave and stainless steel fixed eye strap.



Photo No.	Description	Part No.	Sheave ø (mm)	Sheave Width (mm)	Rope ø (mm)	Wire ø (mm)	Break Load (kg)	SWL (kg)	Weight (g)
Backstay tensioner									
1	Backstay tensioner system	N02740	45	8	5	5	1300	650	163
2	Backstay tensioner block	91020	35	8	-	5	-	-	277
3	Backstay tensioner block	91040	50	15	-	10	-	-	585
Brass sheave blocks									
4	Single - fixed eye	91200	35	8	4	4	400	200	67
5	Single - fixed eye	91300	45	8	5	5	750	375	106
High load wire rope blocks									
6	Fixed eye	91301	45	8	5	5	1300	650	163
7	Swivel eye	91302	45	8	5	5	1300	650	212
Upright blocks									
8	Single - fixed eye	91400	38	12	8	4	-	-	92
9	Single - fixed eye	91500	51	15	12	5	-	-	160
Aluminium blocks									
10	Single - fixed eye	91600	51	15	12	4	1750	875	155
11	Single - fixed eye	91700	63	18	16	5	3000	1500	248
12	Cheek	91650	51	15	12	4	-	-	141

HIGH LOAD & FOOT BLOCKS

High Load Blocks

Manufactured from marine grade aluminium and grey anodised for high UV stability and durability.

- Sheaves are precision turned from solid 'Ertalyste' bar with a profile that is kind to modern ropes.
- Running on a large diameter centre bearing for easy running under high loads.
- Fitted with a stainless steel bow shackle to allow for snag-free operation.
- Available in three sizes, these blocks are compatible with the toggle connections on our ball bearing mainsheet travellers (page 48).
- Bolt-together construction not only adds to good looks, but allows for easy dismantling should servicing become necessary.



1 82100



2 82200



3 82300

Foot Blocks

Featuring the same side plate and sheave construction as the high load blocks detailed above

- Hollow stainless steel rivets allow for through-bolt fastening, giving added strength.
- Through-bolt mounting also means that these blocks can easily be stacked to achieve double block capabilities. Note: stacking blocks will reduce working loads.
- Fastenings of the minimum diameter suggested should be used to gain full load capability (see page 61 for fastening size specifications).
- Ensure that suitable mounting pads are used under deck.



Foot blocks have a three bolt fixing and can be stacked to achieve doubles.

Foot Blocks With Cam

Available in two sizes; specifications as per our high load foot block range. Suitable for a multitude of uses, including locking control lines on headsail furling gear.

Max holding power of cams:
50mm - 250kg 65mm - 300kg.



4 82995



5 82996



6 82997



7 82998



8 82999

Photo No.	Description	Part No.	Sheave ø (mm)	Sheave Width (mm)	Rope ø (mm)	Break Load (kg)	SWL (kg)	Length (mm)	Weight (g)
High load blocks									
1	50mm High load block	82100	50	15	12	1000	500	116	146
2	65mm High load block	82200	65	18	16	1600	800	142	267
3	85mm High load block	82300	85	21	18	3000	1500	185	551
Foot blocks									
4	Foot block - 50mm	82995	50	15	12	1000	500	79	114
5	Foot block - 65mm	82996	65	18	16	1600	800	100	211
6	Foot block - 85mm	82997	85	21	18	3000	1500	132	427
Foot blocks with cams									
7	Foot block - 50mm	82998	50	15	12	1000	500	84	130
8	Foot block - 65mm	82999	65	18	16	1600	800	105	230



"After thousands of sea miles using Barton kit on my yacht, with faultless performance, I had no hesitation stocking Barton at my yacht chandlers."

Alasdair Flint
Managing Director
Arthur Beale
Yacht Chandlers

BARTON INNOVATION

At Barton, we have a dedicated team designing and manufacturing for a global market of sailors who demand performance, quality and innovation. We are committed to continual improvement of product performance using new materials and manufacturing techniques while creating novel new additions to our lines.

We remain customer lead. Barton's engineering expertise will always reflect the requests and feedback from customers, dealers and distributors.

Launching from Barton Designer's Workbook...

The Barton Ratchet Block is ideally suited to racing dinghies and catamarans, dayboats and cruisers for mainsheet, jib and spinnaker control systems

- 55mm hard anodised aluminium sheave, in titanium silver with 12 faces
- Break Load 1200 kg
- SWL of 300 kg
- Lockable swivel



1 90500

The Barton Ratchet Block

Photo No.	Product No.	Break load (kg)	SWL (kg)	
1	Barton Ratchet block - 55mm hard anodised	90500	1200	300

BARTON INNOVATION

The innovative no knot boating accessory

This innovative no-knot marine accessory is a fast and easy way to secure lines up to 6mm. This safe, low profile spring loaded locking cleat is easy to install. High density nylon composite and stainless steel construction provides a working load of 13.5 kg. Quick Cleat is ideal for:

- Kayaks
- Canoes
- Paddleboards
- Water Toys
- Painter Lines
- Fenders
- Boat Gear
- Boat Covers
- Buckets, Nets, Fishing gear



- QUICK**
No knots
- EASY**
... to install and use
- DURABLE**
High strength construction



Photo No.

1 Quick Cleat™ - Reinforced nylon

Product No.

60020

BESPOKE & CUSTOMISED PRODUCTS

Barton's technical expertise assists both discerning boat builders and customers wishing to upgrade their existing boats by designing new track systems. Whether those are for a drilled, sliding bolt, or beam type of tracks, Barton can meet owners exacting dimensions for curved track, be it a horizontal, vertical or compound curve.

Barton Marine works in partnership with commercial marine and general industrial companies to produce innovative bespoke equipment. We provide solutions to complex design problems and produce final customised products.



The Workboat Deployment Block

Custom designed quad block fixed to hydraulic ram – working in conjunction with 15 other Barton blocks and Dyneema rope to lift a highspeed rib onto a large support boat.

HIGH LOAD EYES

High load low friction eyes

High Load Eyes

Available in six sizes. Manufactured in marine grade aluminium with a hard anodised finish.

These lightweight high load eyes are suitable for a variety of uses on board, from lazy jacks, barber haulers, mast base tidies to stanchion lead eyes. The smallest size can be attached using a 3mm line with a bullseye diameter of 6mm. The largest size can be attached using a 16mm line with a bullseye diameter of 28mm.

1 60449



2 60450



3 60451



4 60452



5 60453



6 60454



Ergonomically designed to maximise the strength and efficiency of the eye. With HV500 hard anodising and the profile of the curved surfaces, these have been developed to keep friction as low as possible. The range has amazing strength to weight ratios, making them ideal for use as kickers, tweakers, genoa barber haulers, anywhere where weight saving and strength is important.

Wear Resistance

The hard anodising HV500 has amazing low friction properties. After over 300 hours on an abrasion test machine no visual signs of wear on the anodised coating could be found.

High load eye compared to a standard plain bearing block on average across the range

- Friction increase by only 15%
- Strength increased by 272%
- Weight reduced by 51%

Data based on using 4mm D12 SK75 Dyneema core.

Photo No.	Description	Part No.	External ø (mm)	Internal rope ø (mm)	Bore ø (mm)	Loop length (mm)	SWL (kg)	Weight (g)
High load low friction eye								
1	High load low friction eye - 12mm	60449	12	3	6	-	300	0.8
2	High load low friction eye - 18mm	60450	18	4	9	-	550	3
3	High load low friction eye - 26mm	60451	26	6	12	-	800	5
4	High load low friction eye - 38mm	60452	38	10	16	-	1800	24
5	High load low friction eye - 52mm	60453	52	12	22	-	3300	52
6	High load low friction eye - 65mm	60454	65	16	28	-	4500	104
High load low friction eye with Dyneema loop								
7	High load low friction eye with Dyneema loop - 12mm	60460	-	-	12	100	750	11
8	High load low friction eye with Dyneema loop - 22mm	60461	-	-	22	230	2400	91
9	High load low friction eye with Dyneema loop - 28mm	60462	-	-	28	310	3600	152

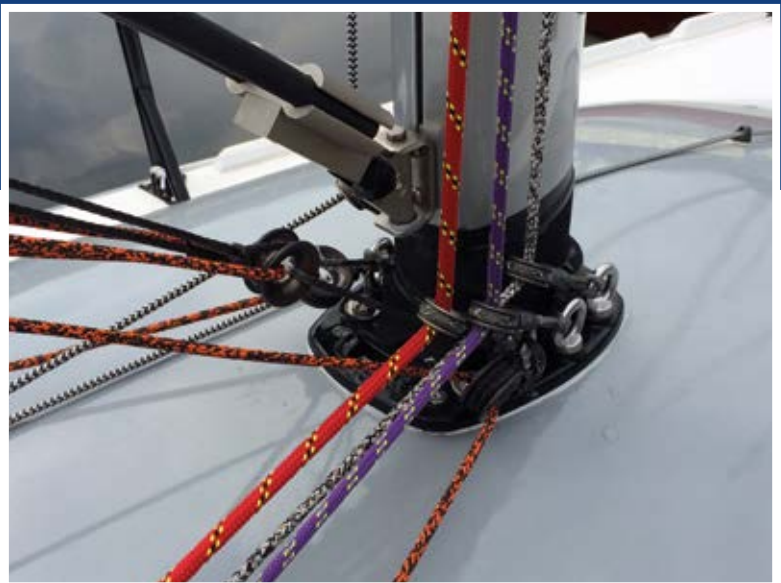

9 60462



8 60461



7 60460



High Load Eye With Dyneema Loop

The Barton high load eye with loop is available in three sizes and can be used in various applications on board including barber hauler, preventers, mast base block ties, emergency blocks, occasional blocks and toe rail blocks etc.

The high load eye combined with the Dyneema loop gives you a fast, efficient, simple and extremely strong solution for changing the direction of any line. The hard anodised aluminium eye is designed to have very good wear resistant properties with low friction, which combined with the high strength Dyneema loop gives you exceptional low weight to very high performance & load ratio.

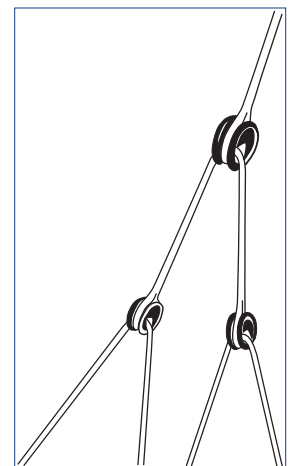
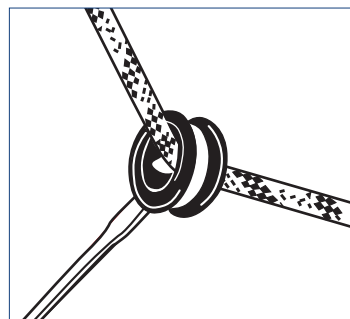
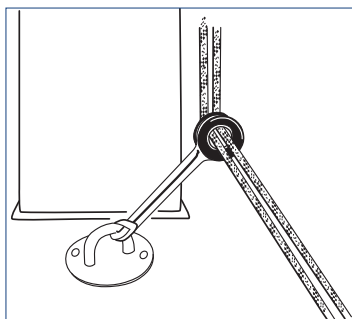
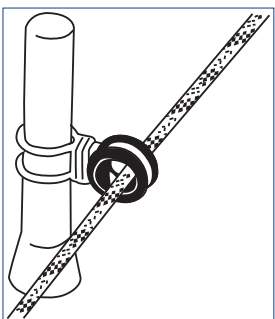

"Our goal is that no one finds Barton products to be inferior or lacking true value. We try to ensure that we only engineer products which stand up to our high standards of endurance, performance and quality."

Dermot Bealey
Production & Operations Manager



TRAVELLER SYSTEMS

Complete packs

Pre-packaged mainsheet systems with all components required in one complete kit - sliding bolt track, traveller, end fittings, plastic end caps, pilot track and full fitting instructions.

Travellers, end fittings and track are manufactured from high quality marine grade aluminium with our unique grey anodised finish for added protection.

Sliding bolt track allows for a smooth, clean profile and also makes retro-fitting easier as bolts can slide along the extrusion to match existing fastening holes.

- Three sizes - for yachts up to 14m LOA (36ft)
- 2:1 or 4:1 purchase systems
- Recirculating precision ground Delrin ball system.

Guide to choice of size

Size 1 for yachts up to 8.5m (28.5ft)

Size 2 for yachts up to 11.0m (36ft)

Size 3 for yachts up to 14.0m (45ft)



2:1 Purchase Kit

with cleats at 70° on end fittings

- 1.4m (size 1) / 1.6m (size 2) / 1.8m (size 3) sliding bolt track
- Traveller car with single shackle take off
- End fittings (pair)
- Plastic end caps (pair)
- Pilot track and fitting instructions

Size 1

20900

Size 2

24900

Size 3

30900



4:1 Purchase Kit

with cleats at 70° on end fittings

- 1.4m (size 1) / 1.6m (size 2) / 1.8m (size 3) sliding bolt track
- Traveller car with single shackle take off
- End fittings (pair)
- Plastic end caps (pair)
- Pilot track and fitting instructions

Size 1

20901

Size 2

24901

Size 3

30901



4:1 Purchase Kit

Incorporating cleats on traveller

- 1.4m (size 1) / 1.6m (size 2) / 1.8m (size 3) sliding bolt track
- Traveller car with single shackle take off
- End fittings (pair)
- Plastic end caps (pair)
- Pilot track and fitting instructions

Size 1

20902

Size 2

24902

Size 3

30902



NOTE: All systems available in black and silver anodised finish

TRAVELLER SYSTEMS

Removable mainsheet system creates more space in the cockpit

The removable mainsheet track system, which is ideally suited for all yachts up to 11.0m (36ft)

This adaptable mainsheet track system is designed to span between the cockpit seats when sailing but is easily removed to give maximum cockpit space when you want to relax on board. A perfect solution for converting coach roof mainsheet sheeting systems to one that is within reach of the helmsman, offering greater sail control and safety.

The removable track system is available in two sizes and can be used on yachts up to a maximum of 11.0m (36ft). The track has a maximum unsupported length of up to 700mm (28in). It can be attached and removed in seconds and uses Barton's beam section track.

All systems available in black anodised finish

1 20090



Barton Marine's removable track system is simple to install. End plates are bolted on both sides of the cockpit. Slide the track under these plates and then lift vertically, which automatically locks in position. To remove the mainsheet track, simply push in the locking pins on each side, lower the track and slide it out.

Specifications	Size 1	Size 2
Max unsupported length	400mm	700mm
H Height	27mm	34.5mm
W Width W Width W2	20mm 26mm	26mm 34mm

Beam track

Use beam track when spanning cockpits or companionway hatches, where unsupported length is required. A minimum of three fastenings should be used on either side of the unsupported length - place fastenings at 100mm centres in supported sections.

Ensure washers are fitted under the head of the bolt and between track & deck to ensure a secure seal.

Photo No.	Part No.	Max unsupported length
Beam track end fittings (pair)		
1	Fits size 1 20003 beam track	20090
	Fits size 2 24003 beam track	24090
		400mm
		700mm
Beam track		
	Size 1	Size 2
	Per metre	20003
	0.6 metre	20013
	1.2 metre	20023
	1.8 metre	20033
	End cap (pair)	20100
	24100	
Complete removable mainsheet track system kits		
	Part No.	
2	Suitable for yachts up to 8.5m (28.5ft)	20910
	Suitable for yachts up to 11.0m (36ft)	24910

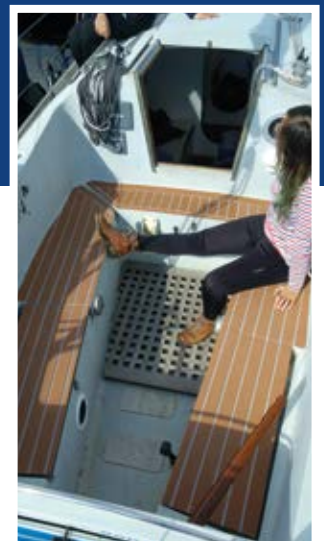

Barton's removable mainsheet system creates more space in the cockpit



2 20910

Complete removable mainsheet track system kits

- Part no 20910** Suitable for yachts up to 8.5m (28.5ft)
- Size 1 beam track 1m length
 - 1 pr removable mainsheet track plates
 - 4:1 traveller system with cleats on the traveller
- Part no 24910** Suitable for yachts up to 11m (36ft)
- Size 2 beam track 1m length
 - 1 pr removable mainsheet track plates
 - 4:1 traveller system with cleats on the traveller

Available in black and silver anodised finish

The maximum unsupported span of the beam track is

Size 1 = 400mm for yachts up to 8.5m (28ft)

Size 2 = 700mm for yachts up to 11.0m (36ft)

(Size 2 = 900mm for yachts up to 9.75m (32ft))

A pelican hook assembly mid track connected to a floor mounted pad eye doubles the unsupported length, visit <http://www.bartonmarine.com/products-removable-mainsheet-systems.asp> for more information.

MAINSHEET SYSTEMS

Modular components for recirculating ball bearing traveller systems

Choose the individual components required to build the system which is the most suitable for your boat. See pages 48 to 51 for pre-designed combinations available.

Available in black and silver anodised finish

- Recirculating precision ground Delrin ball system.
- Three sizes for yachts up to 14m LOA (46ft).
- Build your choice of traveller, cleating system and end fittings

Guide to choice of size:

Size 1 for yachts up to 8.5m (28.5ft)

Size 2 for yachts up to 11.0m (36ft)

Size 3 for yachts up to 14.0m (46ft)

Please see our suggested boat size table on page 10 & 11.



Traveller car

With double shackle take off and internal control line sheaves.

Size 1	Size 2	Size 3
20103	24103	30103



Traveller car

With single toggle take off and internal control line sheaves.

Size 1	Size 2	Size 3
20105	24105	30105



Traveller car

With double toggle take off and internal control lines.

Size 1	Size 2	Size 3
20107	24107	30107



End fitting cleat plate

At 90° to track (supplied in pairs).

Size 1	Size 2	Size 3
20113	24113	30113



Traveller cleat plate assembly

(supplied in pairs).

Size 1	Size 2	Size 3
20117	24117	30117



End fitting cleat plate

At 70° to track (supplied in pairs).

Size 1	Size 2	Size 3
20114	24114	30114

Double take off travellers

With either shackle or toggle attachments, these allow coarse/fine tune mainsheet systems to be achieved. They can also be used with a link plate (page 50) to allow for increased rolling load with the longer cars (see page 12).

Control line sheave cage

Size 1 uses a plain bearing sheave, sizes 2 and 3 feature our low friction large diameter ball bearing sheave system.



Control line sheave cage

For use on travellers and end fittings (supplied in pairs).

Size 1	Size 2	Size 3
20112	24112	30112

	Length (mm)	Weight (g)	Width (mm)	Sheave ø (mm)	Max control line ø (mm)
Control line sheave cage					
Size 1 - 20112	41	15	38	20	6
Size 2 - 24112	52	27	49	30	8
Size 3 - 30112	65	42	57	35	8

MAINSHEET SYSTEMS

Travellers - recirculating ball bearing - Single take off

The unique Barton modular system allows a wide variety of systems to be constructed, giving multiple control line options. In the following tables, order both part numbers listed (where appropriate) for the traveller illustrated.

Shackle take off

Feature a high load forged stainless steel pivoting shackle.

Toggle take off

Feature a solid cast stainless steel upstand with a soft rubber anti-tumble bearing fitted, preventing damage when blocks are not under load. These take offs accept the swivel post from our cruiser blocks and help achieve a truly low profile system.

All systems available in black or silver anodised finish



Traveller car

With single shackle take off and internal control line sheaves.

Size 1	Size 2	Size 3
20101	24101	30101



Traveller car

With single shackle take off and integral control line sheaves 2:1 or 3:1 purchase.

Size 1	Size 2	Size 3
20101	24101	30101



Traveller car

With single shackle take off 4:1 purchase. Comprises:-

Size 1	Size 2	Size 3
20101	24101	30101
20112	24112	30112

Order both part numbers to achieve the product shown



Traveller car

With single toggle take off 4:1 purchase. Comprises:-

Size 1	Size 2	Size 3
20105	24105	30105
20112	24112	30112

Order both part numbers to achieve the product shown



Traveller car

With cleats and single shackle take off 4:1 purchase. Comprises:-

Size 1	Size 2	Size 3
20101	24101	30101
20117	24117	30117

Order both part numbers to achieve the product shown



Traveller car

With cleats and single toggle take off 4:1 purchase. Comprises:-

Size 1	Size 2	Size 3
20105	24105	30105
20117	24117	30117

Order both part numbers to achieve the product shown

MAINSHEET SYSTEMS

Travellers - recirculating ball bearing - double take off



Traveller car

With double shackle take off and integral control line sheaves 2:1 or 3:1 purchase.

Size 1	Size 2	Size 3
20103	24103	30103



Traveller car

With double toggle take off and integral control line sheaves 2:1 or 3:1 purchase.

Size 1	Size 2	Size 3
20107	24107	30107



Traveller car

With double shackle take off 4:1 purchase. Comprises:-

Size 1	Size 2	Size 3
20103	24103	30103
20112	24112	30112

Order both part numbers to achieve the prouct shown

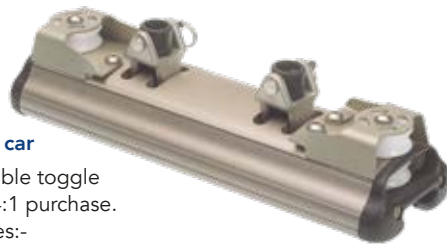

Traveller car

With double toggle take off 4:1 purchase. Comprises:-

Size 1	Size 2	Size 3
20107	24107	30107
20112	24112	30112

Order both part numbers to achieve the prouct shown



Traveller car

With cleats and double shackle take off 4:1 purchase. Comprises:-

Size 1	Size 2	Size 3
20103	24103	30103
20117	24117	30117

Order both part numbers to achieve the prouct shown



Traveller car

With cleats and double toggle take off 4:1 purchase. Comprises:-

Size 1	Size 2	Size 3
20107	24107	30107
20117	24117	30117

Order both part numbers to achieve the prouct shown



Link plate

For long double toggle take off cars. Heavy duty stainless plate that spans toggles - for heavy duty applications.

Size 1	Size 2	Size 3
20202	24202	30202

All systems available in black and silver anodised finish

End fittings - recirculating ball bearing

The unique Barton modular system allows a wide variety of systems to be constructed, giving multiple control line and cleating options for track end fittings.

In the following tables, order both part numbers listed (where appropriate) for the traveller end fitting illustrated.



End Fitting

2:1 or 3:1 purchase (supplied in pairs).

Size 1	Size 2	Size 3
20110	24110	30110



End fitting

4:1 purchase (supplied as a pair of each p/no).

Size 1	Size 2	Size 3
20110	24110	30110
20112	24112	30112

Order both part numbers to achieve the product shown



End fitting with cleat at 90°

2:1 or 3:1 purchase (supplied as a pair of each p/no).

Size 1	Size 2	Size 3
20110	24110	30110
20113	24113	30113

Order both part numbers to achieve the product shown



End fitting with cleat at 70°

2:1 or 3:1 purchase (supplied as a pair of each p/no).

Size 1	Size 2	Size 3
20110	24110	30110
20114	24114	30114

Order both part numbers to achieve the product shown



End fitting with cleat at 90°

4:1 purchase (supplied as a pair of each p/no).

Size 1	Size 2	Size 3
20110	24110	30110
20113	24113	30113
20112	24112	30112

Order all part numbers to achieve the product shown



End fitting with cleat at 70°

4:1 purchase (supplied as a pair of each p/no).

Size 1	Size 2	Size 3
20110	24110	30110
20114	24114	30114
20112	24112	30112

Order all part numbers to achieve the product shown



Crash stop for Genoa track

(supplied in pairs.)

Size 1	Size 2	Size 3
20310	24310	30310



Torlon balls

Torlon ball packages available for all traveller sizes.

	Size 1	Size 2	Size 3
Short	20200	24200	30200
Long	20201	24201	30201

Travellers

Aesthetic design, clean lines, high-tech materials and finishes all go to make this range of traveller cars a functional and practical enhancement for any sailboat.

All end fittings feature a soft rubberised moulded cap, designed to withstand high impact without causing damage.

Standard travellers run on precision ground Delrin balls.

A Torlon ball package is available where higher load applications are required. Torlon balls give up to 40% more load bearing capacity. These packages are available in all three sizes and for long or short travellers.

	Length single take off (mm)	Length double take off (mm)	Weight single take off (g)	Weight double take off (g)	Width (mm)	Fastenings (mm)	Width control line cleats (mm)	Height 2:1 (mm)	Height 4:1 (mm)	SWL (kg)	Max control line ø (mm)
Travellers											
Size 1	132	204	252	411	57	4	98	30	43	500	6
Size 2	166	254	547	923	70	6	120	44	57	700	8
Size 3	198	292	872	1378	87	6	130	47	65	1000	8

End Fittings

	Length (mm)	Weight (g)	Width (mm)	Width with control line cleats (mm)	Height 2:1 (mm)	Height 4:1 (mm)	Max control line ø (mm)
End fittings							
Size 1 - 20110	67	117	59	100	39	50	6
Size 2 - 24110	88	234	72	127	50	65	8
Size 3 - 30110	96	362	85	137	60	74	8

Cam cleats

From our Kevlar 'K' cam range. See page 86 and 87 for full details.

TRACK

MODULAR COMPONENTS

Track 20mm / 26mm / 30mm

Per metre or in set lengths - choose from the table below.

Lightweight hollowed aluminium track that retains high load capacity.

The grey anodised finish is extremely durable and adds to the friction-free efficient performance of these products.

Three styles of track are available – drilled, sliding bolt and beam:

Drilled track

The most commonly used, drilled and countersunk at 100mm centres, with the first hole at 50mm from track end.

Specifications	SIZE 1	SIZE 2	SIZE 3
W Width	20mm	26mm	30mm
H Height	12mm	15mm	18mm
 Fastenings	5mm	6mm	8mm



Sliding bolt track

To allow for a smooth profile with no visible fastenings. Also makes retro fit an easier job, as bolts can slide along the extrusion to match existing fastening holes.

Ensure washers are fitted beneath track to ensure a good seal (see diagram).

Specifications	SIZE 1	SIZE 2	SIZE 3
W Width	20mm	26mm	30mm
H Height	12mm	16.5mm	19mm
 Fastenings	5mm	6mm	8mm



Beam track

Use beam track when spanning cockpits or companionway hatches, where unsupported length is required. A minimum of three fastenings should be used on either side of the unsupported length - place fastenings at 100mm centres in supported sections.

Ensure washers are fitted under the head of the bolt and between track and deck to ensure a secure seal (see diagram).

Specifications	SIZE 1	SIZE 2	SIZE 3
Max unsupported length	400mm	700mm	800mm
W Width 1	20mm	26mm	30mm
Width 2	26mm	34mm	40mm
H Height	27mm	34.5mm	40.5mm
 Fastenings	6mm	8mm	10mm



Curved track

Track can be custom curved to special requirements.

Please enclose a detailed drawing when ordering, giving all dimensions of curvature.

Find out more at: <http://bartonmarine.com/tech-info-track-curving-specification.asp>

All systems available in black and silver anodised finish



Photo No.		Size 1	Size 2	Size 3
Drilled track				
1	Per metre	20000	24000	30000
	0.6 metre	20010	24010	30010
	1.2 metre	20020	24020	30020
	1.8 metre	20030	24030	30030
	2.4 metre	20040	24040	30040
	3.0 metre	20050	24050	30050
	5.0 metre	20060	24060	30060
2	End cap (pair)	20001	24001	30001
Sliding bolt track				
4	Per metre	20002	24002	30002
	0.6 metre	20012	24012	30012
	1.2 metre	20022	24022	30022
	1.8 metre	20032	24032	30032
	2.4 metre	20042	24042	30042
	3.0 metre	20052	24052	30052
	5.0 metre	20062	24062	30062
	End cap (pair)	20001	24001	30001
Beam track				
5	Per metre	20003	24003	30003
	0.6 metre	20013	24013	30013
	1.2 metre	20023	24023	30023
	1.8 metre	20033	24033	30033
	2.4 metre	20043	24043	30043
	3.0 metre	20053	24053	30053
	5.0 metre	20063	24063	30063
3	End cap (pair)	20100	24100	30100

MAINSHEET SYSTEM

I SECTION TRACK & TRAVELLERS

19mm I Section Track & Traveller

For yachts up to 7.3m (24ft) LOA.

A comprehensive range of traveller systems suitable for use on dinghies, dayboats and light cruising yachts.

Also ideal for use in self-tacking jib systems on larger yachts and catamarans.

Manufactured from marine grade aluminium and stainless steel. I section track is silver anodised. Fittings are black anodised.

- Stainless steel captive bearing ball race wheels
- Rugged, lightweight I section track
- Various control line options
- Cam cleat versions feature 'K Cam' Kevlar cleats



1 19100



2 19103



3 19900

6 19000

4 19901

5 19902

Photo No.	Part No.	End fitting	Length (mm)	Width (mm)	Break load (kg)	SWL (kg)	Weight (g)	
19 mm Traveller cars								
1	4 Wheel plain	19100	19900	52	38	1200	600	127
2	4 Wheels, control cleats + sheaves	19103	19902	122	75	1000	500	339
19mm Track end fittings (pair)								
3	Adjustable plunger stops	19900	-	38	29	-	-	83
4	Plastic track end	19901	-	-	-	-	-	16
5	End fitting - horizontal sheave	19902	-	45	22	-	-	44

Photo No.	Part No.	
19 mm I Section track		
6	Per metre	19000
	0.6 metre	19010
	1.2 metre	19020
	1.8 metre	19030
	2.4 metre	19040
	3.0 metre	19050
	5.0 metre	19060
	Track end cap (pair)	19901

19mm I Section Track

Extruded with a hollow section for lightweight and high load capacity. Drilled for fastenings and plunger stops.

Supplied in metric lengths as shown in the table above.

W	Width W	19mm		Fastenings	5mm
H	Height	24mm		Fastening centre	100mm
W	Width X	11mm		Plunger hole centres	50mm



Weight 479g per m

MAINSHEET SYSTEM

I SECTION TRACK & TRAVELLERS



3 26110



1 26101



7 26000

6 26902

4 26900

2 26102

5 26901

24mm I Section Track & Traveller

For yachts up to 10.7m (35ft) LOA.

A mid range of traveller systems, manufactured from marine grade aluminium and stainless steel. All feature heavy duty attachments. Control line blocks (where fitted) have low friction ball bearing sheaves, accepting lines up to 8mm diameter. I section track is silver anodised. Fittings are black anodised. End fittings are secured through track with track fastening bolts.

- Heavy duty take off attachments
- Stainless steel captive bearing ball race wheels
- Ball bearing control line blocks
- End fittings give varied control line options
- Cam cleat versions feature 'K cam' Kevlar cleats.

Photo No.	Part No.	End fitting	Length (mm)	Width (mm)	Break load (kg)	SWL (kg)	Weight (g)	
24mm Traveller cars								
1	4 Wheel plain	26101	26900	69	47	2560	1280	257
2	4 Wheels, control line sheave	26102	26110	69	47	2560	1280	287
24mm Track end fittings (pair)								
3	End fitting with sheave + cleat	26110	-	90	75	-	-	426
	End fitting with double sheave + cleat	26111	-	90	75	-	-	445
4	Adjustable plunger stops	26900	-	32	30	-	-	64
5	Plastic track end	26901	-	-	-	-	-	20
6	Crash stop	26902	-	32	30	-	-	36

Photo No.	Part number	
24 mm I Section track		
7	Per metre	26000
	0.6 metre	26010
	1.2 metre	26020
	1.8 metre	26030
	2.4 metre	26040
	3.0 metre	26050
	5.0 metre	26060
5	Track end cap (pair)	26901

24mm I Section Track

Extruded with a hollow section for lightweight and high load capacity. Silver anodised drilled for fastenings and plunger stops.

Supplied in metric lengths as shown in the table above.

W	Width W	24mm		Fastenings	5mm
H	Height	28mm		Fastening centre	100mm
W	Width X	16mm		Plunger hole centres	50mm



Weight

721g per m

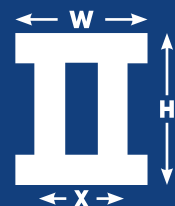

MAINSHEET SYSTEM

I SECTION TRACK & TRAVELLERS

28mm I Section Track & Traveller

For yachts up to 12m (40ft) LOA.

A range of traveller systems for larger yachts up to 12m LOA running on our heavy duty track.

All feature heavy duty attachments, through-bolted for added security. Control line blocks (where fitted) have low friction ball bearing sheaves, accepting lines up to 10mm diameter. I section track is silver anodised. Fittings are black anodised.

End fittings are secured through track with track fastening bolts.

- Stainless steel captive bearing ball race wheels
- Rugged, lightweight I section track
- Cam cleat versions feature 'K cam' Kevlar cleats
- End fittings give varied control line options
- Ball bearing control line blocks.
- Anodised in silver or black.



10 28110



11 28112

Curved track

I section track can be custom curved to special requirements. Please enclose a detailed drawing when ordering, giving all dimensions of curvature.

Find out more at:

<http://bartonmarine.com/tech-info-track-curving-specification.asp>

Photo No.	Part No.	End fitting	Length (mm)	Width (mm)	Break load (kg)	SWL (kg)	Weight (g)	
28mm Traveller cars								
8	4 Wheel plain	28101	28900	88	54	2522	1250	438
9	4 Wheels, control line sheaves	28102	28110	88	54	2500	1250	472
28mm Track end fittings (pair)								
10	End fitting with sheave, becket + cleat	28110	-	108	90	-	-	620
11	End fitting with double sheave, becket + cleat	28112	-	108	90	-	-	724
12	Adjustable plunger stops	28900	-	35	34	-	-	112
13	Track end cup (pr)	28901	-	-	-	-	-	42
14	Crash stop	28902	-	35	34	-	-	76

28mm I Section Track

Extruded with a hollow section for lightweight and high load capacity. Silver anodised drilled for fastenings and plunger stops.

Supplied in metric lengths as shown in the table above.

W	Width W	28mm		Fastenings	6mm
H	Height	34mm		Fastening centre	100mm
W	Width X	17mm		Plunger hole centres	50mm



Weight 1041g per m



15 28000

14 28902

12 28900

8 28101

9 28102

13 28901

Photo No.	Part No.	
28 mm I Section track		
15	Per metre	28000
	0.6 metre	28010
	1.2 metre	28020
	1.8 metre	28030
	2.4 metre	28040
	3.0 metre	28050
	5.0 metre	28060
13	Track end cap (pair)	28901

TOWABLE GENOA CAR SYSTEMS

Towable Genoa Car System

Available in three sizes for yachts up to 14m LOA (46ft) - all three run on the three track types available.

2:1, 3:1 and 4:1 systems can be achieved with the unique Barton modular system.

Modular components are listed on pages 48 to 52.

Featuring a precision turned Ertalyte sheave running on a large diameter bearing.

The bolt through sheave design not only looks good, but gives added strength to these rugged units.



2:1 Purchase system

NOTE: All systems available in black anodised finish



Genoa car

With integral control line sheaves (4:1)

Size 1	Size 2	Size 3
20300	24300	30300
20112	24112	30112



Genoa car

With integral sheaves (2:1, 3:1 or 4:1).

Size 1	Size 2	Size 3
20300	24300	30300



End fitting

With integral sheaves (supplied in pairs).

Size 1	Size 2	Size 3
20110	24110	30110

Order both part numbers to achieve the product shown

	Length (mm)	Weight (g)	Width (mm)	Height (mm)	SWL (kg)	Sheave ø (mm)	Sheave width (mm)
Genoa cars							
Size 1 - 20300	118	400	57	97	500	50	36
Size 2 - 24300	145	775	70	116	700	60	36
Size 3 - 30300	170	1181	87	133	1000	70	45

Working Jib Position

Furled to second marker on foot of Genoa.

Genoa car moved forward from position 2 to position 3 for optimum windward sailing performance.

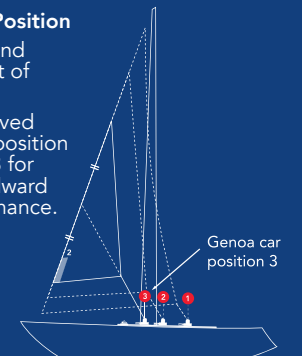

No. 2 Genoa Position

Furled to first marker on foot of Genoa.

Genoa car moved forward from position 1 to position 2 for optimum windward sailing performance.

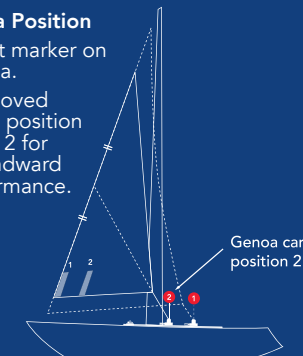

Full Sail

Genoa car in optimum position for windward sailing performance.

Rule of thumb - Sheet lead angle bisects luff length of Genoa.

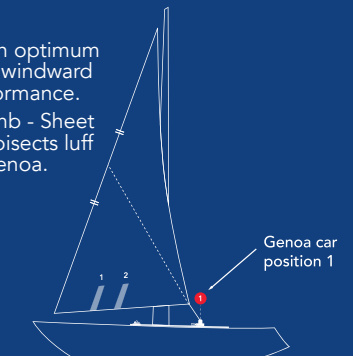

TOWABLE T TRACK GENOA CARS

An established favourite with sailors around the globe, Barton T track genoa cars are compatible with most types of functional T Track. The advantage of a line adjust system is that the crew do not have to leave the safety of the cockpit to obtain perfect headsail trim.

We have developed our current design and have incorporated control line sheaves within the body of the sliders and end fittings. The result is a more compact unit with less likelihood of sheet fouling, plus they look great too!

The towable T track genoa car system is available in three sizes for yachts from 6m –12m (18'–40'), this includes 20mm T track, 25mm T track and 32mm T track (both standard and heavy duty options).

Photo No.		Part No
Genoa cars with towable end fittings		
1	20mm T track towable genoa car	22220
2	20mm T track end fitting (single)	22221
3	25mm T track towable genoa car	25220
4	25mm T track end fitting (single)	25221
5	32mm T track towable genoa car	32210
6	32mm T track towable genoa car (heavy duty)	32211
7	32mm T track end fitting (single)	32221



Please see our suggested boat size table on page 10 & 11, to assist you in making the correct choice when determining the correct size of fitting for your application.

20MM T SECTION TRACK

T section track, sliders, genoa cars

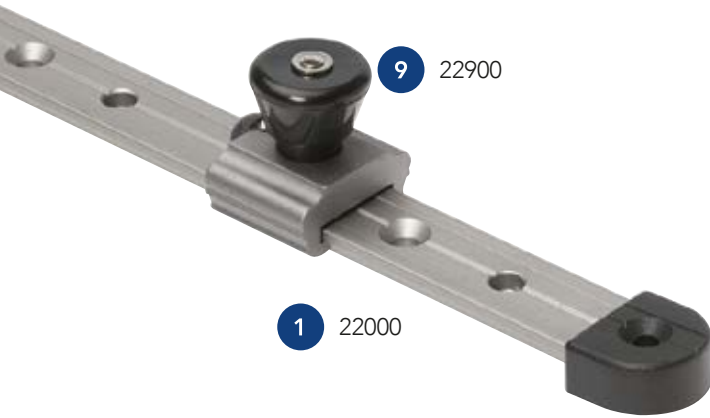

1 22000

9 22900

2 22901



11 22311



13 22312

12 42102



Genoa car with plunger stop

Features a precision turned Ertalyte sheave, through-bolted for extra strength. The positive action plunger mechanism has an easy grip knob (see page 12 for setup options).

Towable genoa cars

With tow eye or sheave in place of plunger, allowing a control line to be led aft so that genoa car adjustments can be made from the cockpit. Use in conjunction with end fittings shown.

Genoa and mainsheet slides

A strong unit which will accept most Barton blocks - with a stainless steel attachment loop, through-bolted for strength.

Bullseye slide

With a swivelling bullseye that will always accommodate the correct angle of sheeting. Accepts lines up to 14mm diameter. A stainless steel insert is provided to prevent wear.

Fairlead slide

Features a plain moulded plastic fairlead fitted to an adjustable slide. Accepts lines up to 12mm diameter; not suitable for high loads.

Stand up block

Has a stainless eye fitted to a stainless loop, through-bolted for strength. The moulded plastic spring/gaiter prevents the block tumbling or ropes snagging. Supplied with a series 2 block accepting lines up to 8mm diameter.

Plunger stops

For use with mainsheet or genoa track sliders. Sold singly.

Photo No.	Part No.	
20mm T section track		
1	Per metre	22000
	0.6 metre	22010
	1.2 metre	22020
	1.8 metre	22030
	2.4 metre	22040
	3.0 metre	22050
	5.0 metre	22060
2	Track end cap (pair)	22901

20mm T section track

For use with all sliders featured on this page. Drilled for fastenings and plunger stops. Grey anodised and supplied in metric lengths.

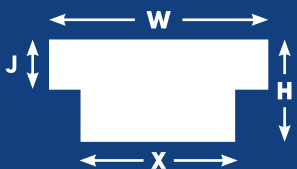

W Width W 20mm
Width X 11mm

H Height H 8mm
Height J 2.5mm



Fastenings Ø 5mm



Fastening centres 100mm



Plunger hole centres 50mm



Weight 270g per m

20MM T SECTION TRACK

T section track,
sliders, genoa cars

Plain bearing genoa cars and sliders

A lightweight and compact range of plain bearing extruded aluminium sliders, running on 20mm (3/4") T track and manufactured from high quality marine grade aluminium with our unique grey anodised finish for added protection.

This useful range will find a wide variety of applications on larger dinghies, dayboats and light cruiser/racers.

See page 10 & 11 for our suggested boat size table designed to help you clarify the correct size of sliders for your application.



Photo No.	Part No.	Length (mm)	Width (mm)	Height (mm)	Sheave Ø (mm)	Max rope Ø (mm)	Break load (kg)	SWL (kg)	Weight (g)	
Genoa cars and towable genoa cars										
3	Genoa car plunger system	22100	60	34	65	30	10	1160	580	119
4	Towable genoa car	22200	110	34	65	30	10	1160	580	127
5	Towable genoa car 2:1 purchase	22220	138	34	65	30	10	1160	580	160
Towable car end fittings										
6	Track end + becket	22221	80	32	47	30	8	-	-	99
Mainsheet/genoa slides and stops										
7	Mainsheet slide	22300	60	32	35	-	-	1200	600	55
8	Genoa slide plunger system	22301	60	32	35	-	-	1200	600	68
9	Plunger stop	22900	30	32	30	-	-	-	-	30
Bullseye and fairlead slides										
10	Bullseye slide plunger system	22310	80	32	60	-	14	400	200	150
11	Fairlead slide plunger system	22311	90	32	42	-	12	400	200	102
12	Fairlead + cam (handed pair) plunger	42102	90	-	-	-	12	-	-	732
Stand up block										
13	Stand up block plunger	22312	75	32	115	35	8	740	370	195
Track end cap (pair)										
2	Track end caps (supplied in pairs)	22901	20	-	-	-	-	-	-	55

25MM T SECTION TRACK

T section track, sliders, genoa cars

Plain bearing genoa cars, sliders and spinnaker pole slides

A popular range of genoa cars and sliders designed to run on 25mm (1") T track. All are manufactured from high quality marine grade aluminium with our silver anodised finish for added protection.

All cars and sliders featured on these pages have moulded nylon inserts to ensure free, smooth running under load and prevent damage to finish or potential corrosion.

- Silver anodised finish
- Stainless plunger stops with positive action
- Moulded nylon slide inserts ensure free running
- Large, easy grip plunger knobs.

Cars and sliders are compatible with most makes of T track.

See pages 10 & 11 for our suggested boat size table designed to help you clarify the correct size of sliders for your application.



Photo No.	Part No.
25mm T section track	
1	Per metre
	0.6 metre
	1.2 metre
	1.8 metre
	2.4 metre
	3.0 metre
	5.0 metre
2	Track end cap (pair)

Photo No.	Part No.	Length (mm)	Width (mm)	Height (mm)	Sheave Ø (mm)	Max rope Ø (mm)	Break load (kg)	SWL (kg)	Weight (g)	
Genoa cars and towable genoa cars										
3	Genoa car plunger stop	25100	80	42	87	40	2 x 12	2280	1140	247
4	Towable genoa car	25200	127	42	87	40	2 x 12	2280	1140	258
5	Towable genoa car 2:1 purchase	25220	170	42	87	40	2 x 12	2280	1140	297
Towable car end fittings										
6	Towable track end + becket	25221	88	37	50	35	8	-	-	121
Mainsheet/genoa slides and stops										
7	Mainsheet slide	25300	80	42	42	-	-	2860	1430	111
8	Genoa slide plunger	25301	80	42	40	-	-	2860	1430	123
9	Plunger stop	25900	30	33	34	-	-	-	-	36
Bullseye slide										
10	Bullseye slide plunger	25303	80	42	60	-	14	-	-	184
Stand up blocks										
11	Stand up block - size 3	25310	80	42	120	45	10	980	490	223
	Stand up block - size 4/5	25311	80	42	142	57	12	1580	790	296
	Stand up block + becket	25312	80	42	150	57	12	1580	790	300
Track end cap (pair)										
2	Track end caps (supplied in pairs)	25901	23	-	-	-	-	-	-	11

25MM T SECTION TRACK

T section track, sliders, genoa cars



25mm T section track
For use with all sliders featured on this page. Drilled for fastenings and plunger stops. Grey or black anodised and supplied in metric lengths.

W	Width W	25mm		Fastenings Ø	5mm
	Width X	14mm			
H	Height H	10mm		Fastening centres	100mm
	Height J	4mm			
	Plunger hole centres	50mm		Weight	441g per m

Sliding cleats

A cost effective solution to fitting a mid-ship spring cleat where access under the side deck is limited - simply remove a genoa track end stop, slide on the cleat and lock it in the desired position.

When not in use, slide the cleat to one end of the track, or leave off one track end permanently to enable easy removal of cleat.

Alternatively, fit a short length of track in the desired position so that cleats can be fitted when required and removed when not in use - reducing deck clutter and rope snags.

25mm cleats have an extruded aluminium base, nylon moulded cleat and screw type lock.

Photo No.	Part No.	Cleat material	Length (mm)	'T' track width (mm)	Weight (g)	
Sliding cleat						
12	165mm sliding cleat	51253	Nylon	165	25	134
13	200mm sliding cleat	51254	Nylon	200	25	178



Photo No.	Part No.	Length (mm)	Width (mm)	Height (mm)	Eye internal Ø (mm)	Weight (g)	
Spinnaker pole slides							
14	Spinnaker pole slide plunger	25302	80	42	74	38	237
15	Towable spinnaker pole slide	25304	80	42	74	38	253



Photo No.	Part No.	Sheave Ø (mm)	Sheave width (mm)	Rope Ø (mm)	Break load (kg)	SWL (kg)	Length (mm)	Fastenings (mm)	Weight (g)	
Foot blocks										
16	Foot block - 50mm	82995	50	15	12	1000	500	79	3 x M6	114
17	Foot block - 65mm	82996	65	18	16	1600	800	100	2 x M6 / 1 x M8	211
	Foot block - 85mm	82997	85	21	18	3000	1500	132	2 x M8 / 1 x M10	427

Genoa car with plunger stops

Features precision turned Ertalyte sheaves running on a large diameter centre bearing, for friction-free performance under load. Sheaves are designed with extra width to accept two sheets. The sheave axle is through-bolted and riveted for extra strength (see page 12 for set-up options).

Towable Genoa cars

With tow eye or sheave in place of plunger, allowing a control line to be led aft so that genoa car adjustments can be made from the cockpit. Use in conjunction with end fittings shown.

Genoa and mainsheet slides

Designed with a heavy duty stainless steel attachment loop, through-bolted and riveted for extra strength. These units will accept most Barton blocks.

Bullseye slide

Features a swivelling bullseye that will always accommodate the correct angle of sheeting. A stainless steel insert is provided to prevent wear. Accepts lines up to 14mm diameter.

Spinnaker pole slide

Features a heavy duty stainless steel ring welded to an attachment plate which is through-bolted to the slide. Generous ring opening to accept most pole ends.

Towable spinnaker pole slide

Eyes are fitted to both ends of the slide for the attachment of control lines. Use with 25210 end fittings (see page 13 for set-up options).

Stand up blocks

Have a stainless steel eye fitted to a stainless steel loop, through-bolted for strength. The moulded plastic spring/gaiter prevents the block tumbling or ropes snagging. Two sizes are available - for 10mm and 12mm lines.

Foot blocks

Designed for use with the genoa cars shown in this range, these strong foot blocks have a three-bolt fixing and can be stacked to achieve doubles. Grey finish. Precision turned Ertalyte sheaves run on large diameter centre bearing to give low friction performance under high loads. See page 38 for further details and our foot block with cam range.

32MM T SECTION TRACK

T section track, sliders, genoa cars

Plain bearing genoa cars, sliders and spinnaker pole slides plus stand up blocks

A popular range of genoa cars and sliders designed to run on 32mm (1¼") T track. All are manufactured from high quality marine grade aluminium with our unique grey anodised finish for added protection.

All cars and sliders featured on these pages have moulded nylon inserts to ensure free, smooth running under load and prevent damage to finish or potential corrosion.

All genoa cars in this range are available in a heavy duty version for larger craft or for larger load applications.

- Grey anodised finish.
- Stainless steel plunger stops with positive action.
- Moulded nylon slide inserts ensure free running.
- Large, easy grip plunger knobs.
- Heavy duty genoa car options.

Cars and sliders are compatible with most makes of 'T' track. Modified slider inserts available for obscure sizes. Please contact Barton Marine for further information.

See pages 10 & 11 for our suggested boat size table designed to help you clarify the correct size of sliders for your application.

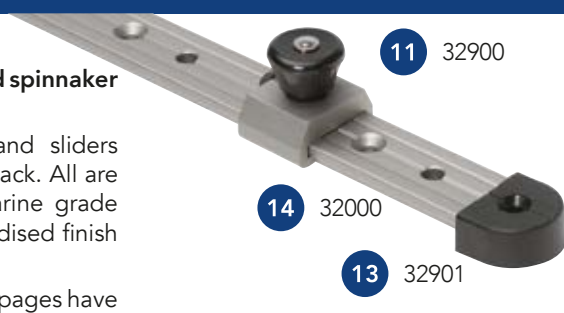

Photo No.		Part No.
32mm T section track		
14	Per metre	32000
	0.6 metre	32010
	1.2 metre	32020
	1.8 metre	32030
	2.4 metre	32040
	3.0 metre	32050
	5.0 metre	32060
13	Track end cap (pair)	32901

Photo No.		Part No.	Length (mm)	Width (mm)	Height (mm)	Sheave Ø (mm)	Max rope Ø (mm)	Break load (kg)	SWL (kg)	Weight (g)
Genoa cars and towable genoa cars										
1	Genoa car	32100	109	52	102	50	2 x 16	3280	1640	469
2	Genoa car - heavy duty	32101	127	55	117	60	2 x 16	5970	2985	728
3	Towable genoa car	32200	170	52	102	50	2 x 16	3280	1640	503
4	Towable genoa car - heavy duty	32201	190	55	117	60	2 x 16	5970	2985	749
5	Towable genoa car 2:1 purchase	32210	220	52	102	50	2 x 16	3280	1640	561
6	Towable genoa car 2:1 purchase - heavy duty	32211	235	55	117	60	2 x 16	5970	2985	820
Towable car end fittings										
8	Track end + becket	32221	109	47	58	45	10	-	-	236
Mainsheet/genoa slides and stops										
9	Mainsheet slide	32300	109	52	50	-	-	2980	1490	231
10	Genoa slide	32301	109	52	50	-	-	2980	1490	254
11	Plunger stop	32900	35	42	40	-	-	-	-	70
Stand up blocks										
12	Stand up block - size 4/5	32310	109	52	150	54	12	1800	900	450
	Stand up block - size 6	32311	109	52	165	60	12	2300	1150	489
	Stand up block - size 7	32312	109	52	170	72	14	2800	1400	565
Stand up blocks										
13	Track end caps (supplied in pairs)	32901	29	-	-	-	-	-	-	19

32MM T SECTION TRACK

T section track, sliders, genoa cars



32mm T section track

For use with all sliders featured on this page. Drilled for fastenings and plunger stops. Grey anodised and supplied in metric lengths.

W	Width W	32mm		Fastenings Ø	6mm
	Width X	20mm			
H	Height H	15mm		Fastening centres	100mm
	Height J	5mm			
	Plunger hole centres	50mm		Weight	756g per m

Sliding cleats

A cost effective solution to fitting a mid-ship spring cleat where access under the side deck is limited - simply remove a genoa track end stop, slide on the cleat and lock it in the desired position.

When not in use, slide the cleat to one end of the track, or leave off one track end permanently to enable easy removal of cleat.

Alternatively, fit a short length of track in the desired position so that cleats can be fitted when required and removed when not in use - reducing deck clutter and rope snags.

32mm cleats have an extruded aluminium base, cast aluminium cleat and plunger type lock.

Photo No.	Part No.	Cleat material	Length (mm)	T track width (mm)	Weight (g)	
Sliding cleat						
15	175mm sliding cleat	51322	Aluminium	175	32	328
16	205mm sliding cleat	51323	Aluminium	205	32	402

Genoa cars with plunger stops

Feature precision turned Ertalyte sheaves running on a large diameter centre bearing, for friction-free performance under load. Sheaves are designed with extra width to accept two sheets. The sheave axle is through-bolted and riveted for extra strength (see page 12 for set-up options).

Towable genoa cars

With tow eye or sheave in place of plunger, allowing a control line to be lead aft so that genoa car adjustments can be made from the cockpit. Use in conjunction with end fittings shown.

Genoa and mainsheet slides

With a heavy duty stainless steel attachment loop, through-bolted and riveted for extra strength. These units will accept most Barton blocks.

Spinnaker pole slide

Has a heavy duty stainless steel ring welded to an attachment plate which is through-bolted to the slide. Generous ring opening to accept most pole ends.

Towable spinnaker pole slide

Have eyes fitted to both ends of the slide for the attachment of control lines. Use with 32220 end fittings (see page 13 for setup options).

Stand up blocks

Have a stainless steel eye fitted to a stainless steel loop, through-bolted for strength. The moulded plastic spring/gaiter prevents the block tumbling or ropes snagging. Three sizes are available - for lines up to 14mm.

Foot blocks

Designed for use with the genoa cars shown in this range, these strong foot blocks have a three bolt fixing and can be stacked to achieve doubles. Precision turned Ertalyte sheaves run on large diameter centre bearing to give low friction performance under high loads. See page 38 for further details and our foot block with cam range.



Photo No.	Part No.	Length (mm)	Width (mm)	Height (mm)	Eye internal Ø (mm)	Weight (g)	
Spinnaker pole slides							
17	Spinnaker pole slide	32302	109	52	80	40	357
	32mm Car with bullseye	32303	109	53	66	18	304
18	Towable spinnaker pole slide	32304	109	52	80	40	359

Photo No.	Part No.	Sheave Ø (mm)	Sheave width (mm)	Rope Ø (mm)	Break load (kg)	SWL (kg)	Length (mm)	Fastenings (mm)	Weight (g)	
Foot blocks										
	Foot block - 50mm	82995	50	15	12	1000	500	79	3 x M6	114
	Foot block - 65mm	82996	65	18	16	1600	800	100	2 x M6 / 1 x M8	211
	Foot block - 85mm	82997	85	21	18	3000	1500	132	2 x M8 / 1 x M10	427

BESPOKE TRACK SYSTEMS

For roofs and other moveable systems

Sliding roof tracks

Barton Marine have many years experience in the design & supply of sliding track systems. (These are often also supplied for the positioning of equipment other than roofs in both Marine & Architectural applications).

Customised Mounting brackets to suit the needs of the Boat builder or Architect

Bespoke Sliding roof systems for both Power & Sailing boats

Anodised Aluminium Track available in silver or black.

Barton can supply a range of standard or customised traveller cars with recirculating ball bearing systems for smooth operation. Available with or without pin stops.

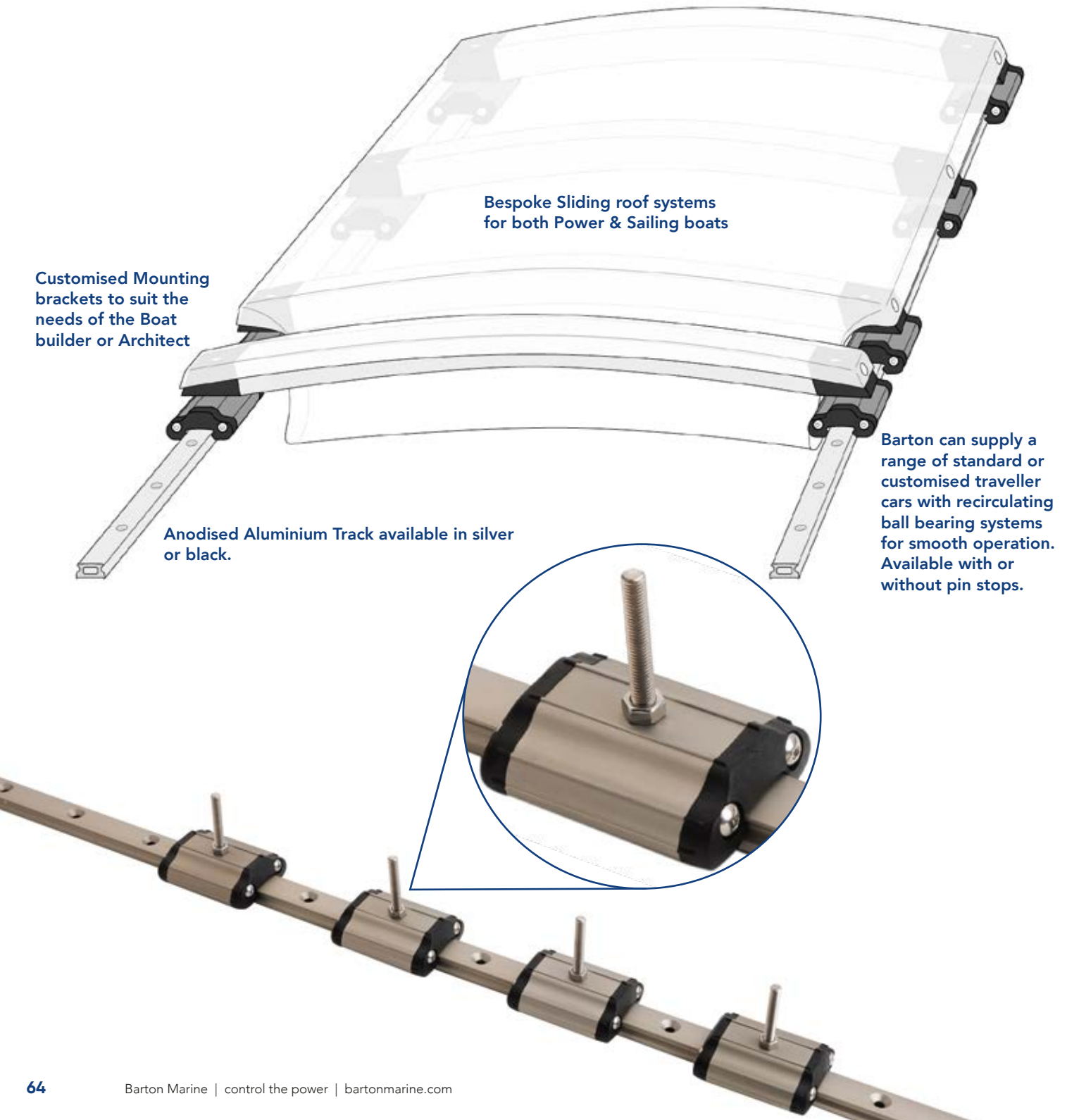



Images courtesy of TBS Boats



"We all so very often endure poor service from all sorts of business... I have received service from Barton which can only be described as extraordinary."

Colin Chett
Barton Customer

DECK ORGANISERS

Available in two sheave sizes and in 2, 3, 4, 5 and 6 sheave models

Designed for use when leading control lines and halyards across the coach roof and back to the cockpit.

This range features aluminium construction with grey or black anodised finish. Sheaves are from moulded Acetal with hollow stainless rivets to allow easy and tidy fitting (see page 13 for set-up options).

Please see our suggested boat size table on pages 10 & 11, to assist you in making the correct choice to determine the right size of fitting for your application.

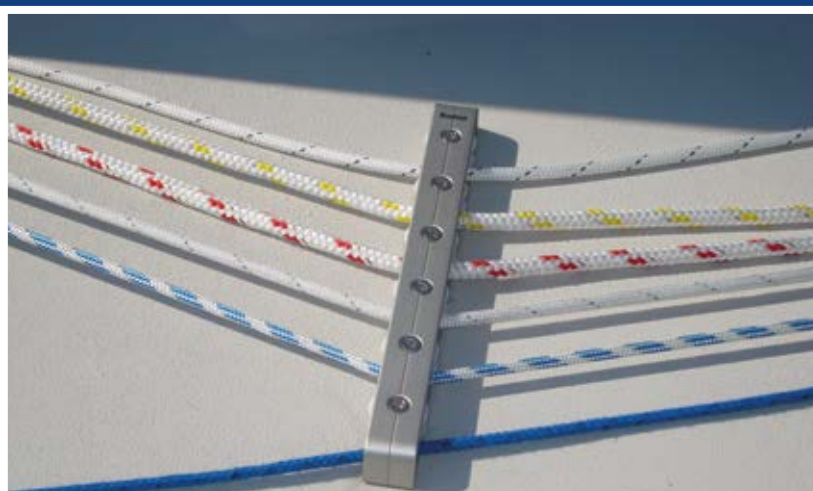

Specifications	SIZE 1	SIZE 2
Sheave Ø	32mm	44mm
Sheave width	17mm	18mm
Hole centres	43mm	58mm
Fastenings	6mm	8mm
Max line Ø	12mm	14mm

1 81582

2 81583

3 81584

4 81585

5 81586



Available in black or silver anodised finish

Photo No.	Part No.	Length (mm)	Width (mm)	Height (mm)	Weight (g)	
Size 1 deck organiser						
1	2-sheave	81582	115	28	25	108
2	3-sheave	81583	157	28	25	155
3	4-sheave	81584	200	28	25	200
4	5-sheave	81585	244	28	25	244
5	6-sheave	81586	287	28	25	295
Size 2 deck organiser						
	2-sheave	81682	148	38	28	205
	3-sheave	81683	205	38	28	290
	4-sheave	81684	262	38	28	378
	5-sheave	81685	318	38	28	465
	6-sheave	81686	376	38	28	555

ROPE CLUTCHES & MAST BASE ORGANISERS





Rope clutches

Manufactured from high grade plastics and aluminium with grey anodised finish.

Lines can be drawn through the clutch in the locked position as the line moves freely in the direction of pull and is restricted from returning by a spring loaded cam mechanism.

This compact range is suitable for securing halyards and control lines on yachts up to approx 30ft - or for lighter duties on large craft (see page 13 for setup options).

Specifications

 Max holding capacity	350kg
 Hole centres	88mm
 Fastenings	6mm
 Max rope capacity	10mm

Locking levers come in grey, red and white and a set of marking stickers is included.

Please see our suggested boat size table on pages 10 & 11, to assist you in making the correct choice when determining the correct size of fitting for your application.



Photo No.	Part No.	Length (mm)	Width (mm)	Height (mm)	Weight (g)	
Rope clutch						
1	Single rope clutch	80500	107	28	62	250
2	Double rope clutch	80501	107	54	62	480
3	Triple rope clutch	80502	107	80	62	710

Mast base organiser

The Barton mast base organiser is finished in our unique grey anodising for a long lasting finish. It accepts up to four double tang blocks mounted on individual stainless steel swivel posts, with just three deck fixing points.

The unit is fitted close to the mast base to accept halyards, reefing lines and topping lift and is designed to work in conjunction with our range of deck organisers, rope clutches and winches, doing away with the need to leave the cockpit when reefing, hoisting or lowering the mainsail (see page 13 for set-up options).

Specification comprises:

- Anodised aluminium base
- Four stainless steel swivel posts with nylon base washers
- Four pairs of nylon packing washers for tang blocks
- Used in conjunction with series 1-4/5 N01090 to N05090 double tang blocks.



Compatible blocks:

N01090, N01091, N11090 and N11091 from page 18
 N02090, N02091, N12090 and N12091 from page 20
 N03090, N03091, N13090 and N13091 from page 22
 N05090, N05091, N15090 and N15091 from page 24

Photo No.	Part No.	Length (mm)	Width (mm)	Height (mm)	Weight (g)	SWL (kg)	Break load (kg)	Fixing hole (mm)	Swivel post	
Mast base organiser										
4	Mast base organiser	81550	160	25	28	166	1540	3080	6	10

BARTON DO 550 CLUTCHES

For cruising and racing yachts, offering a holding power of up to 550kg (see chart below).

Modern, high performance materials

Manufactured from modern lightweight materials, the DO 550 moulded parts are from high grade plastics which are strong, light and impact resistant. Cams and bases are from marine grade aluminium, anodised for long life in the harsh marine environment.

True clutch mechanism

This true clutch mechanism allows lines to be adjusted through the unit in the closed, locked position with minimal slippage. Release under load is positive and requires little effort.

The mechanism's opening and closing action is precise and easy to operate, even with cold, wet hands. A positive handle lock in the closed position is also featured.

Kind to lines

The clutch's cam and base, manufactured from high grade extruded aluminium, feature a specially tempered tooth design which allows for maximum grip with minimal slippage, whilst being kind to your lines.

Stainless steel rope fairleads are fitted to both line entry and exit points; a feature which helps to prevent wear to both clutch and lines.

Bolt-together construction for straightforward servicing

The DO 550 clutch range features the advantage of a bolt-together construction which allows for ease of servicing and replacement of parts. A full range of components is available from your Barton stockist.

Ergonomically designed handle

The handle is strong and easy to grip, with a positive smooth lock and unlock action.

A unique feature of this new design is the removable insert on the top face of the handle. These inserts are available packaged separately with a selection for both cruising and racing yachts.

81540 'Cruiser' insert pack contains: main, genoa 1, spin halyard 1, topping lift, spin pole up, spin pole down, blank.

81541 'Racer' insert pack contains: reef 1, cunningham, reef 2, kicker, mainsheet, genoa furling, genoa 2, spin halyard 2, backstay, outhaul, downhaul, blank.

Please see our suggested boat size table on page 10 & 11, to assist you in making the correct choice when determining the correct size of fitting for your application.

Important fitting notes: rope clutches

When fitting ensure a fair lead straight through the clutch to prevent wear to side plates and/or reduced load capabilities.

For best performance site clutch approximately 1ft (300mm) forward of the winch to ensure a fair lead both vertically and horizontally.

Use Barton deck organisers forward of the clutch to gain perfect alignment.

Always use a bolt-through fastening with a suitable sealant.

A drilling template is provided on our packaging for your convenience.



Photo No.	Part No.	Length (mm)	Width (mm)	Height (mm)	Weight (g)	
DO 550 clutches						
1	Single DO 550 clutch	81500	133	38	68	343
2	Double DO 550 clutch	81501	133	65	68	544
3	Triple DO 550 clutch	81502	133	91	68	754



4 81540 5 81541

Specifications

	Max holding power	550kg
	Hole centres	79mm
	Fastenings	6mm
	Max rope capacity	up to 12mm

Photo No.	Part No.	
Printed handle inserts		
4	'Cruiser' handle insert pack (7 inserts)	81540
5	'Racer' handle insert pack (12 inserts)	81541
Spare parts		
	Handle	81545
	Cam	81546
	Base	81547
	Set of 4 panhead machine screws and nuts	81548

DO 550 clutches - holding power

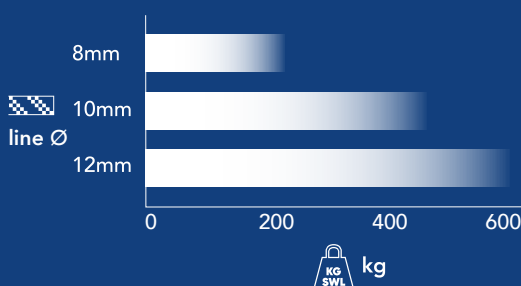

WINCH HANDLES & ACCESSORIES

A range of light duty winch handles and accessories.

All designed to fit international star sockets and standard deck filler caps.

Extruded aluminium handles

Light duty, inexpensive handles in two lengths. Both styles have easy-grip roller handles and anodised finish.

Important note:

These handles should not be used on, two-speed winches as they are not designed for loads in an anti-clockwise direction. SWL 40kg.

1 21001



2 21002



Floating handles

Featuring a moulded body with an integral moulded handle shaft. Locking mechanism has a positive, easy action thumb switch.

Important note:

Floating winch handles have a SWL of 40kg and are intended for lightweight use only.

4 21034



3 21033



5 21323

Reefing gear handle

For use with the now-discontinued '323' roller reefing gear.

PVC winch handle pocket

Manufactured from flexible dip moulded PVC to enable a wide range of handle types to be stored quickly and securely. Includes draining hole at base.

Fabric winch handle pocket

Manufactured from hard wearing synthetic fabric.

6 21050



7 21053



Photo No.	Part No.	Length (mm)	Weight (g)	
Aluminium winch handles				
1	8" Aluminium handle	21001	225	290
2	10" Aluminium handle	21002	280	335
Floating winch handles				
3	10" Floating handle - locking	21033	290	306
4	8" Floating handle - locking	21034	235	267
Special handles				
5	Reefing gear handle	21323	-	160
Winch handle pocket				
6	Fabric winch handle pocket	21050	300	70
7	Moulded PVC winch handle pocket	21053	320	237

BARTON COMPOSITE WINCHES



3 21202

2 21201

1 21200

Barton composite winches

A versatile alternative to conventional steel winches, the Barton range of composite winches offer significant cost and weight savings and are truly low maintenance.

Virtually self-lubricating, friction-free and corrosion resistant, the ingenious use of advanced materials ensures consistent performance and reliability. The composite drum has a 'moulded in' stainless steel insert for wear resistance.

- Three models available - a single-speed 8:1 and two twin-speeds; 16:1 and 23:1
- Suitable as primaries for yachts up to 10m (30ft) or as spinnaker/halyard winches on larger craft
- Red, blue and green coloured top rings are included, giving you the ability to colour-code winches to control lines, port or starboard, or just to match the colour scheme of your boat
- Comprehensive spares kits available.

(see page 12 for setup options).

See pages 10 & 11 for our suggested boat size table designed to help you clarify the correct size of winch for your application.

Snubbing winch

Neat, lightweight unit which is ideal for use on larger dinghies and dayboats. Manufactured from glass fibre reinforced nylon with anodised aluminium ribs.



4 21101

Photo No.		Part No.	Base Ø (mm)	Drum Ø (mm)	Weight (g)
Sheet winches					
1	Single speed 8:1	21200	101.6	66.7	835
2	Twin speed 16:1	21201	114.3	66.7	1264
3	Twin speed 23:1	21202	114.3	66.7	1600
Snubbing winch					
4	Snubbing winch	21101	75	50	230
Spare kit					
	Single speed 8:1	21210	-	-	-
	Twin speed 16:1	21211	-	-	-
	Twin speed 23:1	21212	-	-	-

THE BARTON 'WINCHER'

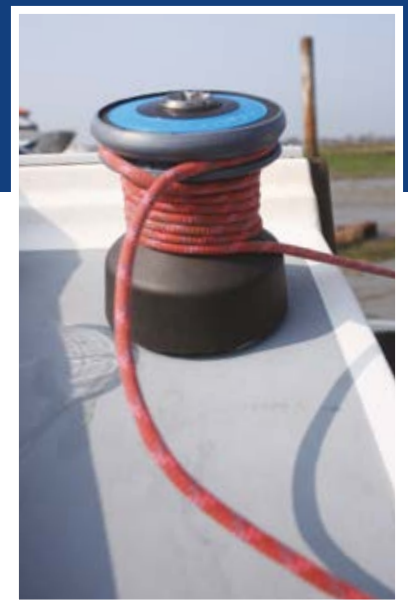

A specially designed rubber moulding which fits over the top of standard winches, converting them to self-tailing.

This simple operation works when the line is sheeted under load, which means the coils climb up the winch drum and then become gripped by the underside of the Wincher's rubber body. Cleating is achieved by locking the sheet into the Wincher's ribbed central groove.

The Barton Winchers are easy to fit and available in four sizes to suit a wide range of popular winches.

Full fitting instructions are included.



1 21643

SMALL
 Ø 64-70mm
 2 1/4 - 2 3/4"
 Ø 8-10mm
TO FIT
 Barton 21200, 21201, 21202
 Antal W8
 Lewmar 7, 7ct, 8, 12ct, 16
 Harken B8, B16.2

MEDIUM
 Ø 70-80mm
 2 3/4 - 3"
 Ø 10-14mm
TO FIT
 Antal W9, W16, W30
 Lewmar 30, 40
 Harken B32.2, B40.2

LARGE
 Ø 80-90mm
 3 - 3 1/2"
 Ø 12-14mm
TO FIT
 Antal W42
 Lewmar 44

EX LARGE
 Ø 90-100mm
 3 1/2 - 4"
 Ø 12-16mm
TO FIT
 Antal W44, W47, W48
 Harken B42.2

Photo No.	Part No.	Top flange of winch (Actual measurement)	Max drum Ø (mm)	Max rope Ø (mm)	Weight (g)	
Barton 'Winchers'						
	Wincher small (pair)	21641	98mm	64-70	8-10	202
	Wincher medium (pair)	21642	102mm	70-80	10-14	223
1	Wincher large (pair)	21643	120mm	80-90	12-14	278
	Wincher extra large (pair)	21644	130mm	90-100	12-16	387

"I have used Barton fittings for years. The reason is simple. They just never broke. So when it came to the two-handed Fastnet Race it was obvious I would go to Barton."

Chris Lewns
Barton Customer



LAZY JACK KITS & MAST STEP

Allow mainsails to be dropped with ease, by retaining the sail between lines running from the mast (near the hounds) to the boom. These lines can be slackeden whilst sailing to avoid restricting sail shape.

Ideal for use with fully battened or conventional mainsails, these complete kits contain stainless steel, plastic-coated wires with blocks and fixing eyes attached. High quality braided line, all fixings and comprehensive fitting instructions are also included.

A unique feature of Barton lazy jack kits is the soft plastic block covers which prevent sail chafe and enhance appearance.

Lightweight lazy jack kits

These all-rope kits still feature our unique block covers but are intended for smaller yachts or lightweight use.

Not recommended for large yachts or fully battened mains. We also recommend that the use of a topping lift is retained.

Cascade lazy jack kits

Available in standard and lightweight format. For use with longer boom lengths or where more sail control is required.

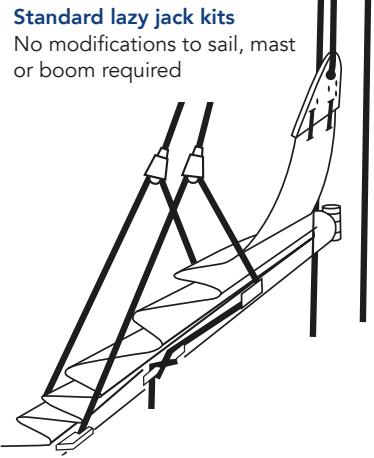

Cascade lazy jack kits
Blocks, cleats, mounting eyes and fixings included in the kit.

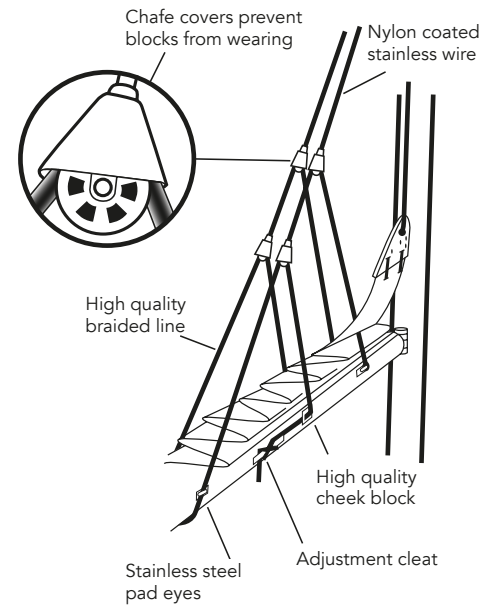

Photo No.	Part No.
Lightweight lazy jack kits	
1 For yachts up to 9m (30ft)	41140
2 Cascade system for yachts up to 10.5m (35ft)	41143
Lazy jack kits	
3 For yachts up to 9m (30ft)	41150
For yachts up to 12m (40ft)	41151
For yachts up to 12m (40ft)	41152
Cascade system for larger yachts	41153

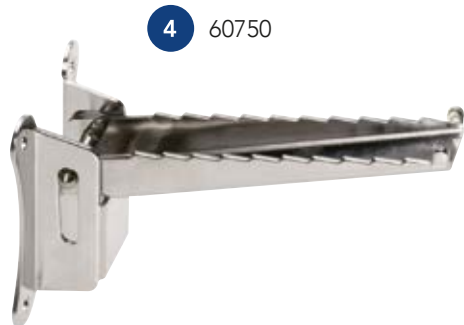

Photo No.	Part No.
Mast step	
4 Mast step (stainless steel)	60750

Mast step

Low profile, lightweight hinged mast step, manufactured from bright polished stainless steel.

Featuring a secure and positive hinge action to ensure that the product is rattle-free. The foot hold area has a toothed non-slip surface and the profile turns up at the outboard end for a firm and secure foothold.

Secure using 4 x 5mm pop rivets and fit at 500mm spacing (as shown in the adjacent diagram).

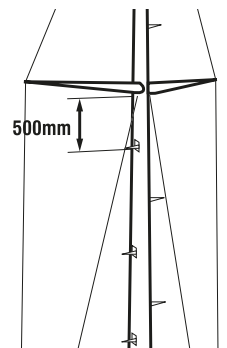

Mast Steps: Mast steps should always be used in conjunction with a Bosun's chair. Always have a crew member at hand to control the halyard. Do not go aloft barefoot and always put safety first when going aloft.

REEFING KITS & HOOKS

Single line reefing kit

A boxed complete single line reefing kit that allows reefing lines to be led aft to the safety of the cockpit.

This system makes reefing your mainsail a quick and easy operation - just lower the main to a predetermined mark on the halyard, tension the reefing line and re-trim the sail.

Supplied as a complete set with all the parts and fixings required, together with full fitting instructions. All you need to provide is a line and a cleat or stopper.

Slab reefing kits

Supplied with sliding blocks which are held in place with spring-loaded plungers. Manufactured from stainless steel and anodised aluminium. Available in two sizes and complete with a length of T track and end tops.

Specifications

41483 supplied with 60cm of 25mm anodised 'T' track

41496 supplied with 100cm of 32mm anodised 'T' track

Photo No.		Part No.
Single line reefing kit		
3	For yachts up to 9m (30ft)	41130
Slab reefing kit		
4	For yachts up to 8.5m (28ft)	41483
	Spare slider for above	41484
5	For yachts up to 12m (40ft)	41496
	Spare slider for above	41497

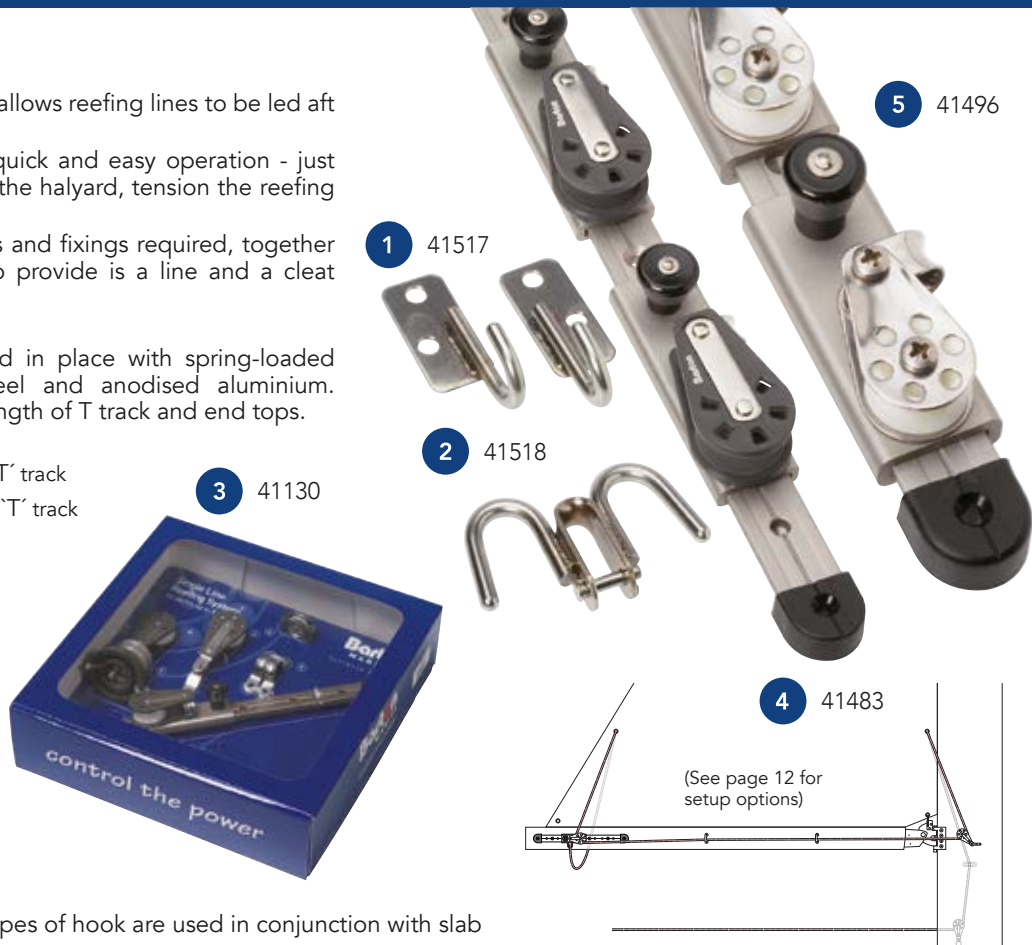

Reefing/gooseneck hooks

Manufactured in stainless steel, both these types of hook are used in conjunction with slab reefing kits for securing the mainsail tack.

Type **41517** is supplied in pairs and is intended for mounting either side of the boom at gooseneck level.

Type **41518** can be mounted above the gooseneck or can be used at the stemhead to accept a jib tack.

Photo No.		Part No.
Reefing hooks		
1	Boom fitting (pair)	41517
2	Gooseneck or stemhead fitting	41518



Stanchion lead blocks

Mainly used for leading headsail furling lines aft, Barton stanchion blocks are available in three sizes to suit most applications.

A larger size 4/5 block should be used for final take off, especially if the furling line is to be lead to a winch.

All stanchion blocks are available with either plain or ball-bearing sheave.

Photo No.		Part No.		Sheave Ø (mm)	Max line Ø (mm)	Max tube Ø (mm)
		Plain sheave	Ball bearing sheave			
Stanchion lead blocks						
6	Single stanchion - Size 2	N02190	N12190	35	8	25
7	Double stanchion - Size 2	N02290	N12290	30	10	25
8	Single stanchion - Size 3	N03190	N13190	45	10	25
	Single stanchion - Size 4/5	N05190	N15190	58	12	25
Stanchion bullseye						
10	Stanchion bullseye		60142			Bullseye internal diameter 17mm



BARTON BOOMSTRUT

Six sizes to suit yachts up to 12m/40ft LOA

Patented flexing spring provides fast response and a constant force for vang efficiency

The boomstrut's lightweight, low-profile design features two flexible coated fibreglass rods which provide the force to support the boom. Pulling the boom down with a conventional kicker causes the Boomstrut to flex; releasing straightens the rods, thereby lifting and supporting the boom.

Maintenance-free, durable design

Eliminates friction and sliding parts.

Improved performance

Less weight and windage.

Easy installation

There's no need to replace your existing hardware - the Boomstrut mounts independently inside the existing kicking strap tackle.

Simple to follow instructions

The Boomstrut is supplied with complete fitting instructions and more comprehensive details are available on our website, www.bartonmarine.com.

Mast fitting can use existing luff groove

To eliminate drilling, the Boomstrut's mast bracket can be slotted into your mast's luff groove.

Contoured boom fitting

The Boomstrut's boom bracket is contoured to fit both round and flat boom profiles.

Carefully designed & constructed

The Barton Boomstrut has been carefully designed and constructed to eliminate sharp edges, minimise parts and provide trouble-free installation and use.

All parts are from high grade stainless steel and black or grey anodised aluminium for good looks and durability. Spare parts available.



Available with
webbing cradle
for rotating booms

Boomstrut
compressed

You'll find many reasons to appreciate the Barton Boomstrut

- Improved control of sail shape.
- No topping lift needed.
- Easy to adjustment and no hang-ups.
- Never again will your boom fall accidentally.

“Easy to fit, simple to use and maintenance free... the Barton Boomstrut with its black anodised finish, represents a cool, discrete contrast to the flashy chrome of other suppliers” Paul Durkin *Barton Customer*

Maintenance free | Fits in minutes | No drilling required

With no extra parts or drilling required, the Dinghy Boomstrut is simply tied off at the mast to secure in place, negating the need for drilling. At the top of the rods, a fully adjustable webbing cradle supports the boom and as the cradle is not directly attached to the boom, it does not restrict the boom from rolling around its central axis to follow the sail when reefing.

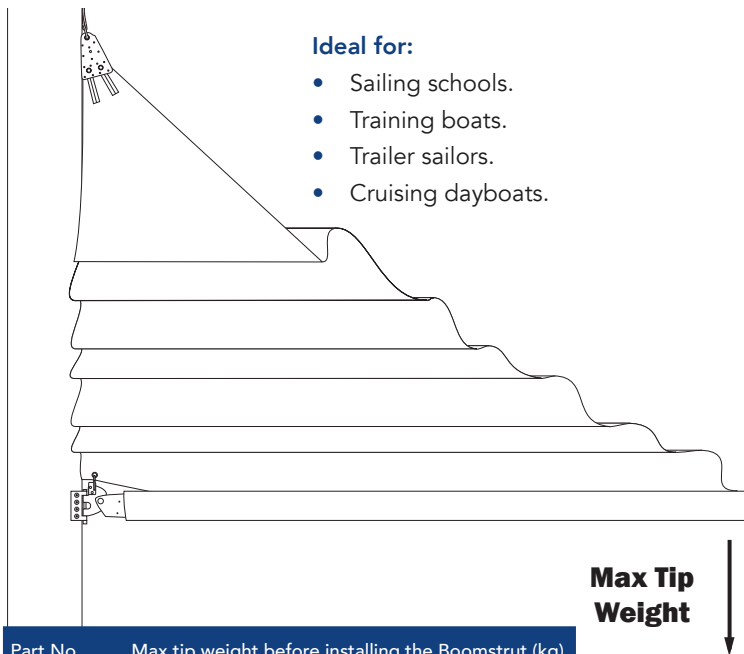

Ideal for:

- Sailing schools.
- Training boats.
- Trailer sailers.
- Cruising dayboats.

Part No.	Max tip weight before installing the Boomstrut (kg)
44001	5
44010	6.3
44020	9.5
44030	15
44035	19
44040	23

To see a full list of yachts fitted with our Boomstrut please go to:

www.bartonmarine.com/products-boomstrut-boats-fitted.asp

Also for a comprehensive range of spare parts please visit:

<http://www.bartonmarine.com/products-boomstrut-fitting-instructions.asp>



Boomstrut



Dinghy Boomstrut



Dinghy Boomstrut

Suggested boat length	Part No.	Pin-to-pin length (mm)	max rods can be reduced by* (mm)	Max initial full adjustment** (mm)	Max stroke at full adjustment (mm)	Force*** (kg)
Barton Boomstrut						
Dinghy	44001	762	125	130	150	45
Up to 6m	44010	960	150	300	150	90
6m to 7.5m	44020	1070	150	300	150	140
7.5m to 9m	44030	1180	150	300	150	185
9m to 10.5m	44035	1320	150	400	200	230
10.5m to 12m	44040	1450	150	400	200	270

*The maximum amount the Boomstrut rods can be shortened to fit inside the vang area.

** The maximum amount of available pin-to-pin travel when flexed.

*** The downward force the Boomstrut will support at the point of the boom fitting attachment.

These are approximate measurements which may vary depending on boat type.

WEAR PADS & LINE TAMERS

Designed to help sailors and power boaters protect key areas of a boat's deck and superstructure from abrasion, chips, scuffs and wear, our wear pads can be applied wherever there is a need to protect a boat's finish without compromising its appearance.

How to fit wear pads

Ensure that the surface is perfectly clean; remove all traces of dirt, salt, moisture and grease. For rough surfaces, ie. non slip deck surfaces, lightly sand the surface with sandpaper for better adhesion. Align the pad and trim to size with scissors if necessary. Press down firmly with a hard edged plastic tool which is the full width of the pad or disc to provide the necessary pressure at the point of lamination.



Photo No.	Part No.
1	67170



PUR (polyurethane) clear wear pads

The Barton 'Line Tamer'

A line storage device designed to keep cockpits free from unused lines and halyards. A smooth profile ensures no snagging as crew members brush past. Sold in pairs in grey or white.

Full fitting instructions are included. Suitable for rope coils of up to 20cm diameter.



Photo No.	Part No.	Material	Length (mm)	Weight (g)	Fastening Ø (mm)
2	52000	Nylon	73	12	-
3	52001	Nylon	73	12	-

Recirculating ball bearing dinghy traveller range

Complementing Barton's successful larger traveller range, the dinghy traveller system uses proven recirculating Delrin ball technology and features a 16mm wide track.

With holding power of up to 130kgs; the attachment eye allows the system to be easily secured to our block range, creating powerful purchase ratios.

Travellers, end fitting and track are manufactured from high quality marine grade aluminium with our unique grey or black anodised finish for added protection.

See pages 10 & 11 for our suggested boat size table designed to help you clarify the correct size of traveller for your application.

1 18101



2 18105



3 18110



4 18111



8 90500



5 18112





6 18000



7 18001



Specifications

	Maximum boat size	5.5m (18ft)
	SWL	130kg (286lbs)

Drilled track specification

W	Width	16mm
H	Height	9mm
	CSK	4mm
	Hole centres	50mm



Photo No.	Part No.
Dinghy travellers	
1	Traveller car with single shackle take off 18101
2	Traveller car with single toggle take off 18105
3	End fitting (supplied in pairs) 18110
4	Control attachment eye (supplied in pairs) 18111
5	Loop eyes (supplied in pairs) 18112
Drilled track	
6	Per metre 18000
	0.6 metre 18010
	1.2 metre 18020
	1.8 metre 18030
	2.4 metre 18040
	3.0 metre 18050
	5.0 metre 18060
7	Track end cap (pair) 18001
8	Barton ratchet block - 55mm hard anodised 90500

NOTE: All systems available in black or silver anodised finish

TILLER EXTENSIONS

Manufactured from 15mm diameter aluminium and available in a wide variety of lengths.

All Barton tiller extensions feature our flexible joint which can easily be removed from the tiller when required.

- Manufactured from anodised aluminium.
- Available with either foam or plain button end options.

Photo No.		Part No.
Ali extensions - plain button		
1	Tiller extension - ali - plain button 600mm	43101
2	Tiller extension - ali - plain button 700mm	43102
3	Tiller extension - ali - plain button 800mm	43103
4	Tiller extension - ali - plain button 900mm	43104
	Tiller extension - ali - plain button 1050mm	43105
	Tiller extension - ali - plain button 1200mm	43106
Ali extensions - foam grip		
5	Tiller extension - ali - foam grip 600mm	43201
6	Tiller extension - ali - foam grip 700mm	43202
7	Tiller extension - ali - foam grip 800mm	43203
8	Tiller extension - ali - foam grip 900mm	43204
	Tiller extension - ali - foam grip 1050mm	43205
	Tiller extension - ali - foam grip 1200mm	43206

Flexible tiller joints

Manufactured from high tech polymers to withstand countless tiller flexings.

The tiller extension can easily be removed from the tiller assembly by popping off the snap-on cover.

Two versions are available - light flexible joint giving a softer action for shorter extensions.

Photo No.		Part No.	Length (mm)	Tube int. Ø (mm)	Weight (g)
Flexible tiller joints					
9	Light flexible tiller joint	43600	58	13	20
	Flexible tiller joint	43601	58	13	20
Tiller clip					
10	Tiller clip	43605	-	-	-



9 43600

10 43605

CARBON TILLER EXTENSIONS

Features the latest in uni-directional 16mm carbon fibre tube which incorporates an additional pullwound spiral layer for optimum strength, making it stronger than conventional carbon fibre tube and with our custom designed foam grip handle to reduce fatigue during long periods of use. Includes tiller clip.



Photo No.	Part No.
1	Length 0.6m 43500
2	Length 0.7m 43501
	Length 0.8m 43502
3	Length 0.9m 43503
4	Length 1m 43504
5	Length 1.2m 43506
6	Length 1.5m 43509
7	Length 2m 43514
8	Length 2.1m 43515

DINGHY & DAYBOAT

Bullseye swivels with cam cleat

Swivel bullseye accepts lines up to 12mm Ø and features a stainless steel insert and 'K' cam cleat with top fairlead.

1 42102



Fairleads

Fairleads with plunger and cam cleat for use on 20mm T track (see page 58 for complete range of 20mm T track fittings). Sold in handed pairs. Includes budget cam cleat fixed on stainless steel plate.

Sheet fairlead - a moulded plastic fixed fairlead.

Spinnaker fairlead - a moulded plastic sheet fairlead with snap in/out hook design.

Drain bungs and sockets

This screw type drain bung and socket is still among the best available. Supplied with rubber 'O' ring for a watertight seal. Available in black or white.

Rudder and transom fittings

Manufactured from stainless steel with tough nylon surrounds. A wide range of rudder fitting widths are available.

Rigging adjuster

Manufactured from 16mm stainless steel plate - allows for total 50mm adjustment in 10mm steps. Clevis pin 5mm Ø. Overall length 91mm.

2 42200



3 42201



Photo No.	Part No.	Length (mm)	Fastenings Ø (mm)	Max line Ø (mm)	Weight (g)	
Foot blocks						
1	Fairlead + cam (handed pair)*	42102	90	5	12	732
2	Sheet fairlead	42200	65	5	14	16
3	Spinnaker fairlead	42201	75	4	8	8

Photo No.	Part No.	Bore Ø (mm)	Cutting Ø (mm)	Fastenings Ø (mm)	Weight (g)	
Drain bungs and sockets						
4	Bung + socket - black	42356	15	22	4	11
5	Bung only - black	42357	15	-	-	7
6	Bung + socket - white	42358	15	22	4	11
7	Bung only - white	42359	15	-	-	7

4 42356 5 42357 6 42358 7 42359



Photo No.	Part No.	Strap width (mm)	Pintle Ø (mm)	Fastenings Ø (mm)	Weight (g)	
Rudder and transom fittings						
8	Rudder pintle	42419	19	9.5	5	91
	Rudder pintle	42422	22	9.5	5	95
	Rudder pintle	42435	35	9.5	5	104
	Rudder pintle	42450	50	9.5	5	114
9	Rudder gudgeon	42519	19	-	5	81
	Rudder gudgeon	42522	22	-	5	82
	Rudder gudgeon	42535	35	-	5	91
	Rudder gudgeon	42550	50	-	5	101
10	Transom pintle	42400	-	9.5	5	70
11	Transom gudgeon	42500	-	-	5	30

11 42500



12 42601



10 42400



Photo No.	Part No.	Max line Ø (mm)	Base Ø (mm)	Fastenings Ø (mm)	Weight (g)	
Bullseye swivel with cam						
12	Bullseye swivel with cam	42601	12	58	5	172

Rigging adjuster

13	Rigging adjuster	42700	-	-	-	-
----	------------------	-------	---	---	---	---

8 42419

9 42519

13 42700



REPLICA LASER KITS

1 Laser Replica 15:1 Kicking strap assembly (98075) upgraded to Ball Bearing blocks

The Barton kicking strap assembly gives all the advantages of systems costing twice the price. 15:1 purchase is achieved through clever design of the base plate, fitted with the unique Barton swivelling triple cam block. It is simple to fit and easy to use.

- Contains:**
- Barton base plate, anodised aluminium with three fixing bolts.
 - N10930** Series 0 triple, swivel, cam block attached to base plate by shackle.
 - N10110** Series 0 single fixed eye block attached to base plate by shackle.
 - N10211** Series 0 double block with becket.
 - N11091** Series 1 single tang block with becket and curved kicker key for boom.
 - 1.2m x 4mm Dyneema for primary red control line.
 - 3m x 4mm line for secondary red control line.

2 Laser Replica Outhaul assembly (98076) upgraded to Ball Bearing Blocks

The Barton outhaul assembly is class legal offering the same purchase as standard systems fitted. Our outhaul is simple, lightweight, strong and comes with a simple toggle release for the main sail clew.

- Contains:**
- N10110** Series 0 single fixed eye (fitted to short red strop).
 - N10111** Series 0 single fixed eye becket (fitted to primary red line).
 - N10110** Series 0 single fixed eye, (attaches to gooseneck by twist shackle or line – not supplied).
 - Primary line 2m x 4mm red Dyneema, Short strop 0.24m x 4mm red Dyneema.
 - Secondary line 4m x 4mm blue line, Elastic 1.5m x 4mm.

3 Laser Replica Mast base assembly (98077) upgraded to Ball Bearing Blocks

Comprises two size 0 fixed eye blocks built into the stainless steel mount for added security and no risk of twisting.

- Contains:**
- Stainless steel mast base plate with two loops.
 - N10110** Series 0 blocks x 2.

4 Laser Replica Cleat base assembly (98078) upgraded to Ball Bearing Blocks

The replica cleat mount comes fitted with two mini K Cams and our new pillar fairlead design for ease of adjustment from all angles.

- Contains:**
- Cleat base with two fixing holes.
 - 70100** K Cam mini cleats x 2.
 - 70105** K Cam pillar fairleads x 2.

5 Laser Replica Cunningham assembly (98079) upgraded to Ball Bearing Blocks

The Barton Cunningham assembly comes with 8:1 purchase for those who find the standard system a struggle. It is simple to fit and easy to use. Components can be configured to be class legal.

- Contains:**
- N10110** Series 0 single fixed eye (attached to primary red line through sail eye).
 - N10110** Series 0 single fixed eye (attached to secondary yellow line short tail).
 - Primary line 0.44m x 4mm red Dyneema (with long and short loops).
 - Secondary line 3.5m x 4mm yellow line (large loop provided with long and short tails).

Disclaimer:

Barton fittings are high quality replacements that perform the same function as the original part. They should not be confused with official parts bearing the Laser® registered trademark. They cannot be used if you are sailing at an Association event. However, they are perfect for social sailing, sailing schools, club sailing or training. Laser® is a registered trademark owned by Velum Limited and currently licensed for use in Europe to Laser Performance (Europe) Limited.

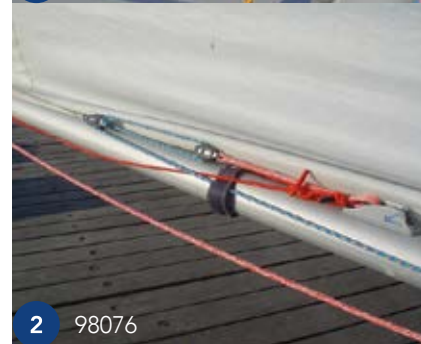

DINGHY MAST SUPPORT

Designed to support the aft end of a dinghy mast when towing or stowed in a dinghy part. Simply fits onto standard transom fittings and is instantly ready for use. Fully adjustable for different transom heights and features a removable pintle to accommodate different transom layouts.

The yoke features a soft neoprene pad to protect the mast, shrouds and lines. Generous eyelets in the yoke allow for a securing line to be easily attached. A trailer board can be fitted to the cross plate with 2 x 6mm screws (not supplied).

- Easy to fit
- No fastenings required
- Fully and easily adjustable
- Increases towing safety
- Prevents damage to mast and deck.

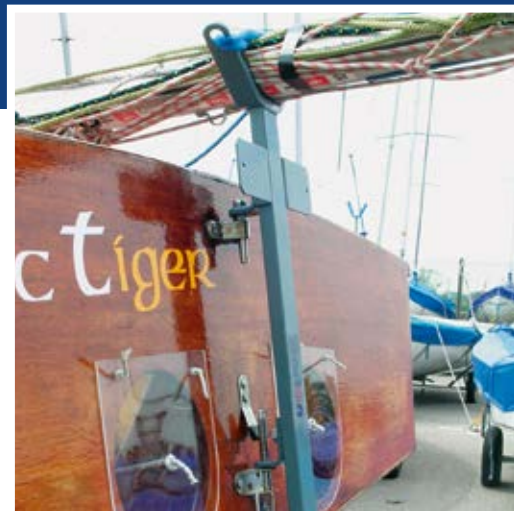
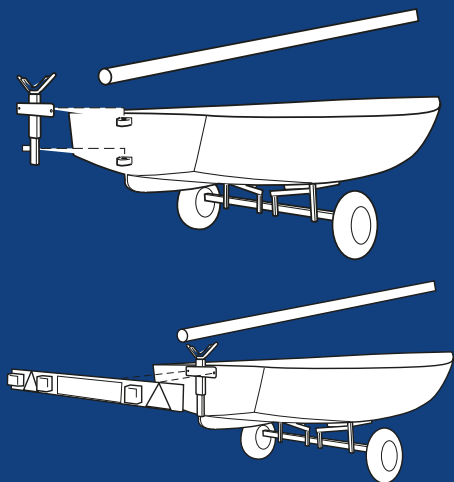
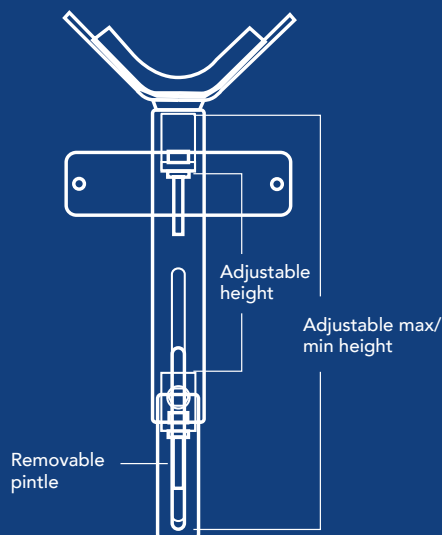

Photo No.	Part No.
Dinghy mast support	
1	Dinghy mast support 42300



Adjust pintles and height of yoke to suit transom fittings and transom height, then tighten the locking nut.

Remove bottom pintle if transom has 2 gudgeons.

Attach trailer lighting board with 2 x 6mm fastenings.

1 42300

Please ensure the use of the light panel bar meets regulations on trailers in your location. Barton Marine Equipment Ltd. accepts no liability for use in areas requiring rear light panels to be directly attached to the trailer.

FURLING GEAR

Single line operation for dinghies, dayboats and light cruising yachts - two drum sizes work with a common top head swivel. All have stainless steel ball races for smooth operation.

Drums are moulded from glass fibre reinforced nylon with stainless steel swivel and ball bearing assemblies.

Top head swivel is from machine turned solid aluminium with stainless steel ball bearings.

Redesigned to enhance style and increase performance.

- 3 point line retention.
- Invisible easy furling line attachment.
- Furling line guides to eliminate line drop.



2 42335



3 42336



1 42334



Photo No.	Part No.	Drum Ø (mm)	Sail area (sq ft)	Break load (kg)	SWL (kg)	Weight (g)	
Furling gear							
1	Small furling drum	42334	76	60	1108	554	218
2	Large furling drum	42335	95	100	1108	554	281
3	Top swivel	42336	25	100	1108	554	55

KEVLAR CAM CLEATS

Manufactured from a Kevlar composite and available in three sizes to accept lines up to 14mm in diameter. This advanced material offers performance advantages over carbon fibre and conventional glass-reinforced resins. K cams are very strong, lightweight and have excellent wear resistance. A progressive tooth design ensures maximum holding power on all types of line, whilst maintaining minimum wear to both cam and line.

'K' cam bases feature a stainless steel wear bar for prolonged life.

Cams utilise stainless steel leaf springs which give a smooth but positive action. They are also stronger and have a longer life than conventional wire springs.

'K' cam cleats are supplied as cleat only plus separate accessories in grey, green, red or yellow where appropriate, to allow colour coordination for port, starboard etc.

Wire front fairleads

From stainless steel.

Pillar fairleads

These add ons enable the cam cleat to be engaged from a variety of angles. Cams can be fitted either way around to achieve a lead from in front or behind. Stainless steel pillars add strength and wear resistance.

Top fairleads

Incorporating stainless steel reinforcing for added strength and wear resistance.

Wedge mounts

Angled wedge mounts to suit the three sizes of 'K' cam cleat.

Cam top caps

Supplied in packs containing two each of red, green and yellow cam top caps.



98078 - see page 83



Specifications	'K' Cam mini	'K' Cam midi	'K' Cam maxi
Max line Ø	10mm	6-12mm	10-14mm
Fastenings Ø	4mm	5mm	5mm
Fastening centres	30mm (1 3/16")	40mm (1 9/16")	50mm (2")
Holding power	190kg	230kg	260kg
Weight	17g	34g	50g



KEVLAR CAM CLEATS

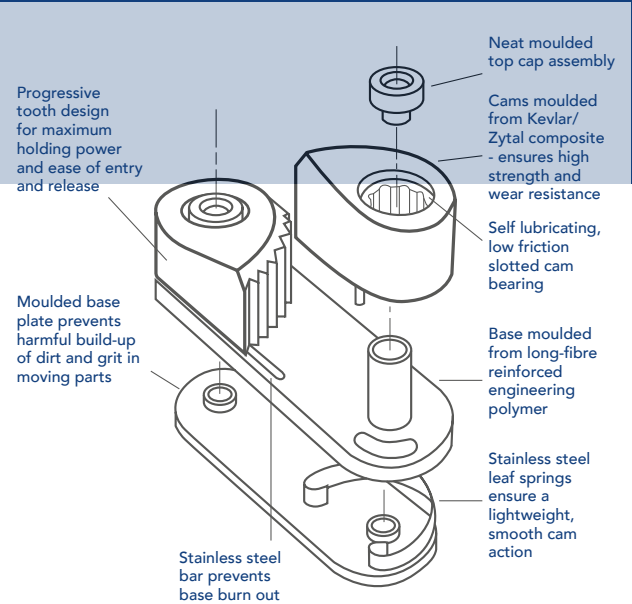

Photo No.		'K' Cam mini	'K' Cam midi	'K' Cam maxi
'K' Cam cleat only				
1	'K' Cam cleat only	70100	70200	70300
'K' Cam cleat with wire front fairlead				
2	'K' Cam cleat with wire front fairlead	70101	70201	70301
Wire front fairlead only				
3	Stainless steel wire front fairlead only	70104	70204	70304
Pillar fairlead only				
4	Pillar fairlead - grey	70105	70205	70305
Top fairlead only				
5	Top fairlead - grey	70106	70206	70306
6	Top fairlead - green	70116	70216	70316
7	Top fairlead - red	70126	70226	70326
8	Top fairlead - yellow	70136	70236	70336
Wedge mount				
9	Wedge mount	70140	70240	70340
Cam top caps				
10	Pack of top caps, 2 x red, green, yellow	70141	70241	70341

Photo No.	Part No.	Max rope Ø (mm)	Fastening centres (mm)	Fastenings Ø (mm)	Holding power (kg)	Base Ø (mm)	Weight (g)
Budget cam cleats							
11	Budget cam cleat mini	70600	10	30	4	-	-
12	Budget cam cleat midi	70601	6-12	40	5	-	-
13	Budget cam cleat maxi	70602	10-14	50	5	-	-

INSPECTION COVERS

Barton offer a wide range of inspection covers in screw and locking versions. Round and rectangular covers are available.

Screw inspection covers

Manufactured from high impact polycarbonate, these covers feature an easy start thread and a built in 'O' ring seal.

Available in four diameters in white, black and clear window.



1 40040 40041 40042



2 40050 40051 40052



3 40060 40061 40062



4 40080 40081 40082

T lock round hatch covers

- Easy locking design.
- Low Profile.
- Integral seal for excellent water resistance.
- UV and weather resistant Saralon resin.



5 40500



6 40502

Photo No.		Part No. White	Part No. Black	Part No. Clear	Aperture Ø (mm)	Cutting Ø (kg)	Overall Ø (mm)	Fastenings Ø (mm)	Weight (g)
Screw inspection covers - round									
1	Screw inspection covers - round	40040	40041	40042	103	114	145	4	84
2	Screw inspection covers - round	40050	40051	40052	130	139	170	4	107
3	Screw inspection covers - round	40060	40061	40062	155	165	215	4	172
4	Screw inspection covers - round	40080	40081	40082	200	215	260	4	400

INSPECTION COVERS



Hinged rectangular inspection covers

Hinged on the top edge, these covers feature the T lock system and a soft rubber seal.

Available in white only. UV and acetone resistant.

T lock hatch covers

- Easy lock design.
- Hidden fasteners.
- Stainless steel hinges.
- Integral seal for excellent water resistance.
- UV and weather resistant Saralon resin.

7 40511



8 40512



9 40513



10 40514



11 40515



Photo No.	Part No.	Colour	Aperture Ø (mm)	Cutting Ø (mm)	Overall Ø (mm)	Fastenings Ø (mm)	Weight (g)	
T Lock hatch covers								
5	223mm (8.75") deck plate locking	40500	Polar White	131	159	223	6 x 5	331
6	273mm (10.75") deck plate locking	40502	Polar White	181	210	273	6 x 5	484
7	280 x 388mm (11 x 15.25") T lock hinged rectangle hatch cover	40511	Polar White	191 x 292	223 x 321	280 x 388	8 x 5	1123
8	280 x 483mm (11 x 19") T lock hinged rectangle hatch cover	40512	Polar White	191 x 394	223 x 423	280 x 483	10 x 5	1458
9	330 x 451mm (13 x 17.75") T lock hinged rectangle hatch cover	40513	Polar White	242 x 356	270 x 385	330 x 451	10 x 5	1528
10	330 x 502mm (13 x 19.75") T lock hinged rectangle hatch cover	40514	Polar White	242 x 413	270 x 442	330 x 502	10 x 5	1702
11	330 x 610mm (13 x 24") T lock hinged rectangle hatch cover	40515	Polar White	242 x 515	270 x 543	330 x 610	12 x 5	2124



"Barton's smooth and professional service to us way down here on the other side of the world is always appreciated."

Matthew Doyle
*Wing Sergeant Major
New Zealand Defence Force*

BULLSEYES, PAD EYES & DECK EYES

Bullseyes

A range of four bullseyes for through-deck or on-deck screw mounting. All feature a strong, moulded plastic eye, reinforced with a stainless steel bar. Two models also feature a stainless steel eye insert to limit wear to the line. All accept lines up to 16mm Ø.

Bullseye swivel with cam cleat

Swivel bullseye accepts lines up to 12mm Ø and features a stainless steel insert and 'K' cam cleat with top fairlead. Fastening 4 x 5mm.

Pad eyes

A wide range of attachment eyes/fairleads manufactured from stainless steel. Featuring a solid stainless steel bar welded for extra security.

Folding pad eye - stainless steel pad eye with anti-vibration rubber pad. Folds flat to deck when not in use.

Double folding pad eye - with anti-vibration rubber pads and two fixing eyes which fold flat when not in use.

Deck eyes (stainless steel)

Two sizes of stainless steel deck eyes with generous eye capacity.

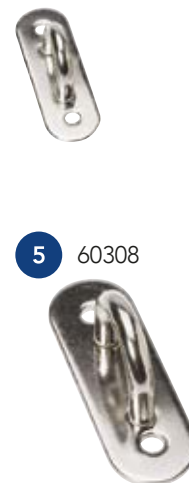

Photo No.	Part No.	Dia Ø 'A' (mm)	Height 'B' (mm)	Hole centre 'C' (mm)	Width 'D' (mm)	Fastenings Ø (mm)
Pad eyes						
1	Pad eye - double folding	60304	6	42	-	6
2	Pad eye - fixed	60305	4	16	30	40
3	Pad eye - fixed	60306	6	24	44	60
4	Pad eye - fixed	60307	8	28	55	80
5	Pad eye - fixed	60308	10	35	60	95
6	Pad eye - folding	60309	6	42	36	54



Photo No.	Part No.	Height 'A' (mm)	Width 'B' (mm)	Fastenings Ø (mm)
Deck eyes				
7	Deck eye - S/S	60410	14	14
8	Deck eye - S/S	60411	18	16



Photo No.	Part No.	Insert	Max line Ø (mm)	'D' (mm)	'L1' (mm)	'L2' (mm)
Bullseyes						
9	Through-deck	60420	✓	16	6	57
10	Through-deck	60421	✓	16	6	77
11	Through-deck	60422	X	16	6	105
12	Screw-to-deck	60423	X	16	6	40

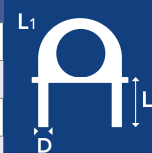

CLEVIS PINS, SPLIT RINGS & SPRINGS

Clevis pins

A comprehensive selection of clevis pins manufactured from 316 stainless steel - as used throughout the Barton range of blocks. Supplied in packs of two.

Stand-up springs

Ideal for mounting blocks on decks to prevent tumbling or causing rope snags and deck damage. Either in stainless steel or soft plastic.

Split rings

Easy-fit stainless steel split rings for use with our clevis pins. Supplied in two sizes and in packs of 10.



Photo No.	Part Number
Split rings	
6	Split ring - 10mm Ø - pack of 10 60190
7	Split ring - 14mm Ø - pack of 10 60191

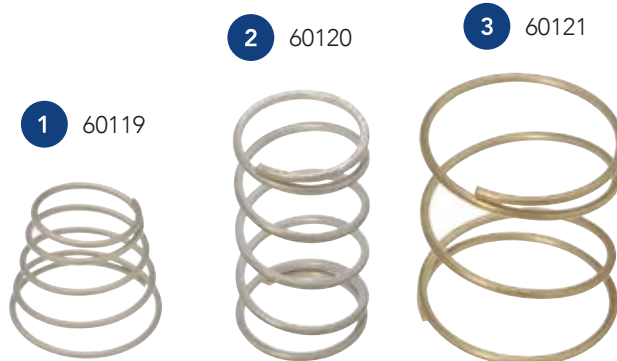

Photo No.	Part No.	Dia Ø 'D' (mm)	Height 'H' (mm)
Stand-up springs			
1	Spring - S/S (tapered)	60119	16/24 20
2	Spring - S/S	60120	20 35
3	Spring - S/S	60121	30 30
4	Spring - plastic	60122	40 50
5	Spring - plastic	60123	48 50

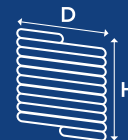
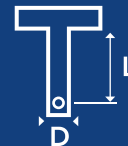

Photo No.	Part No.	Dia Ø 'D' (mm)	Length 'L' (mm)
Clevis pins			
8	Clevis pins (pack of 2)	60203	5 15
	Clevis pins (pack of 2)	60204	5 18
9	Clevis pins (pack of 2)	60207	5 24
	Clevis pins (pack of 2)	60208	5 33
	Clevis pins (pack of 2)	60209	5 39
10	Clevis pins (pack of 2)	60210	6 10
	Clevis pins (pack of 2)	60212	6 23



SHACKLES & 'S' SWIVELS

Shackles

A range of screw pin strip and forged bar shackles in stainless steel - as used throughout the Barton range.

Pin diameters up to 8mm available.



1 60311

2 60312

3 60320

4 60321



8 60701

9 60702

10 60703

'S' hooks

A handy fitting with a multitude of uses. Manufactured from stainless steel. Supplied as either a plain hook or with spring latch fitted.



11 60708

12 60709

Swivels

Stainless steel swivels as used throughout our block range.

Four sizes available.

Photo No.	Part No.	Pin Ø 'D' (mm)	Length 'L' (mm)	Width 'W' (mm)	
Screw pin shackles (strip)					
	Strip shackle	60310	5	27	10
1	Strip shackle	60311	6	38	13
2	Strip shackle	60312	8	50	16
Screw pin shackles (bar)					
3	Bar shackle	60320	6	38	13
4	Bar shackle	60321	6	44	20
	Bar shackle	60322	8	49	16
	Bar shackle	60323	8	55	20
Rigging links					
5	Rigging link	60343	5	30	14
6	Rigging link	60344	6	37	18
7	Rigging link	60350	6	50	19
Swivels					
	Swivel	60700	5	33	8
8	Swivel	60701	5	33	9
9	Swivel	60702	5	33	11
10	Swivel	60703	6	45	14
'S' hooks					
11	'S' hook plain	60708	6	73	19
12	'S' hook with latch	60709	6	73	19



5 60343

6 60344

7 60350

Rigging links

Pressed stainless steel rigging links with clevis pin and ring in pin.

Sizes up to 6mm pin diameter.

CLAM SEAL™



The ClamSeal™

REPAIRS INFLATABLES – FAST

DAME award category winner.
Winner of National Marine Manufacturer's Association Product Innovation award

The award winning, patented ClamSeal™ repairs inflatables fast - even when wet

The ClamSeal™ can instantly repair splits and tears up to 90mm (3½”) in length without the use of any hand tools or adhesive.

ClamSeal™ is a patented glue-less repair system that instantly repairs small tears or splits in inflatables above or below the waterline - regardless of the fact that the material may be wet.

The system works by using two half 'shells' that screw together tightly, using the inflatable material itself as a water and air-tight seal. It is quick and easy to fit and effects an immediate repair which can keep you afloat until a more permanent repair can be made.

- Quick and easy to fit
- Requires no adhesive or tape
- Can be used above or below the waterline
- Can be used on wet materials
- Provides an instant repair
- Re-useable again and again.

The ClamSeal™ can be carried as part of your emergency equipment onboard. It can be used at sea, on shore; even underwater as no adhesive or tape is involved. The clever mechanics of the ClamSeal™ design mean this simple product can keep you safely afloat.

The ClamSeal™ has become a permanent part of the safety kit on RIBs around the world and is continuing to amaze those who have used them - an effective, low cost solution to an otherwise complicated problem.



Pat pending GB0329522.7

Part No.	
Clam Seal™	
Barton Clam Seal™	60001

ClamSeal™ is suitable for use on:

- RIBs
- Dinghies
- Liferrafts
- Buoyancy bags
- Most inflatable products.

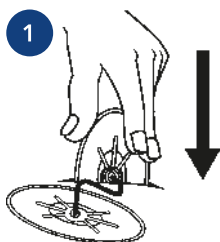

1 Open the ClamSeal™ and insert the base plate into the split.

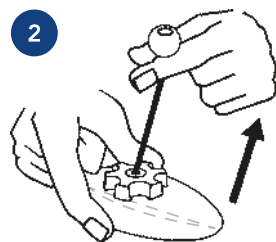

2 Pull the plates of the ClamSeal™ together, across the split, using the lanyard



3 With the two plates pulled together, simply hand tighten the nut for a Clam-tight seal.

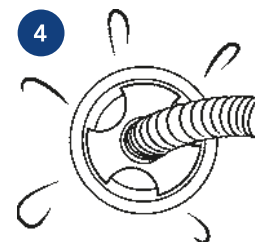

4 Reinflate and you're safe to continue on your way.

SPECIAL CLEATS

A wide range of specialised glass filled nylon cleats designed for a variety of uses onboard



Stanchion cleat

Designed to fit stanchions or pushpit/pullpit tubes - fits in seconds and features soft nylon jaws that will not damage the tube.

Stanchion Bullseye*



Tubular cleats

Available in two sizes, these handy cleats have many uses where light loads are expected.

Photo No.	Part No.	Cleat material	Length (mm)	Weight (g)	Fastening Ø (mm)	
Stanchion cleat						
1	Stanchion cleat	52100	Nylon	111	90	-
Shroud cleat						
2	Shroud cleat	52110	Nylon	100	26	-
3	Shroud cleat with eye	52111	Nylon	100	26	-
Open nylon cleat						
4	Open cleat	52140	Nylon	75	6	3
5	Open cleat	52141	Nylon	100	12	4
6	Open cleat	52142	Nylon	130	26	4
7	Open cleat	52143	Nylon	170	49	5
8	Open cleat	52144	Nylon	210	84	6
9	Open cleat	52145	Nylon	245	157	8
Stanchion bullseye						
10	Stanchion bullseye	60142	Nylon	Bullseye int. Ø 17mm		

*Stanchion Bullseye is suitable for line up to 12mm and fits to stanchions or pushpit/pullpit tubes

Photo No.	Part No.	Length (mm)	Fastenings Ø (mm)	Weight (g)	Bore (int Ø) (mm)	
Tubular cleats						
11	Tube cleat	52120	55	4	4	8
12	Tube cleat	52121	80	6	13	13



Open (horn) cleats

Moulded from high strength black nylon, supplied in a variety of useful sizes.



Shroud cleats

Two handy cleats that simply clamp onto shroud wire (max 8mm Ø) without causing damage.

52110 is a plain cleat for flag halyards etc.

52111 features a wide eye opening for stowage of halyard shackles.

Stainless steel rubbing strakes

Stainless steel rubbing strakes, to help prevent rope wear to deck edges and coamings. Available in three lengths, these attractive strakes are easy to fit and will last a lifetime. Part numbers and sizing information is as follows:



Photo No.	Part No.	
Stainless steel rubbing strakes		
13	203 x 19mm	67100
14	305 x 19mm	67101
15	457 x 19mm	67102

SHEAVES

Sheaves

A comprehensive range of plain and ball bearing sheaves as used throughout the complete Barton block range. Moulded from Acetal resin, our unique, super-low friction ball race system features Delrin balls running on a large diameter centre boss, which ensures an extremely low friction performance.



Sheaves also available in white

Photo No.	Part No.	Dia Ø 'D' (mm)	Height 'H' (mm)	Bore (mm)	
Sheaves - plain bearing					
	Plain bearing sheave	N64800	25	12	8
1	Plain bearing sheave	N64801	30	12	8
	Plain bearing sheave	N64802	32	14	8
	Plain bearing sheave	N64803	32	17	11
	Plain bearing sheave	N64804	35	12	8
	Plain bearing sheave	N64805	35	18	13
	Plain bearing sheave	N64806	38	17	13
	Plain bearing sheave	N64807	44	18	13
	Plain bearing sheave	N64808	44	20	13
	Plain bearing sheave	N64809	45	11	8
	Plain bearing sheave	N64810	45	14	8
	Plain bearing sheave	N64811	48	20	13
	Plain bearing sheave	N64812	58	14	8
	Plain bearing sheave	N64813	58	17	11
	Plain bearing sheave	N64814	64	18	13
	Plain bearing sheave	N64815	72	18	13
	Plain bearing sheave	N64816	72	20	13

Photo No.	Part No.	Dia Ø 'D' (mm)	Height 'H' (mm)	Bore (mm)	
Sheaves - ball bearing					
2	Ball bearing sheave	N64901	30	12	5
	Ball bearing sheave	N64902	32	14	5
	Ball bearing sheave	N64904	35	13	5
	Ball bearing sheave	N64906	38	18	6
	Ball bearing sheave	N64907	44	18	6
	Ball bearing sheave	N64908	44	20	6
	Ball bearing sheave	N64909	45	12	5
	Ball bearing sheave	N64910	45	14	5
	Ball bearing sheave	N64912	58	15	5
	Ball bearing sheave	N64913	58	18	6
	Ball bearing sheave	N64914	64	18	6
	Ball bearing sheave	N64915	72	18	6
	Ball bearing sheave	N64916	72	21	6

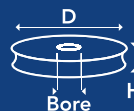

FUEL WHISTLE & EASY SPLICE

FUEL WHISTLE

A simple device to prevent accidental spillages when refuelling

This unique patented product has been designed to give an audible warning to prevent fuel spills during the refuelling of boats. This helps prevent marine pollution and ensures that your topsides and decks are kept free from spills.

- Eco friendly
- Simple to fit
- Protects the environment and your deck
- Suitable for sail and power boats
- Fitting instructions included
- Cost effective

1 60010

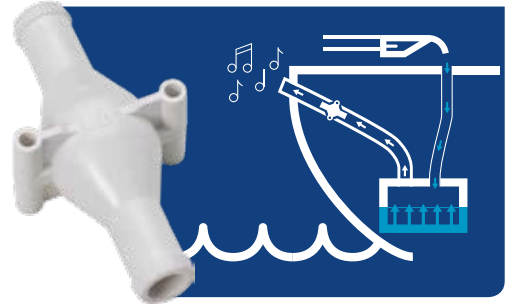

Photo No.	Size	Product No.
1	Fuel whistle	60010

EASY SPLICE

Sailors and Boat Owners are rediscovering the timeless art and skill of rope Splicing.

Splicing is the ability to terminate a rope or join two ends of a rope without using a knot. Barton's EasySplice is designed specifically to make this action simple, fast and precise.

A balanced and lightweight tool that enables faster and easier rope splicing.

- Simple to use - No experience required
- Lightweight design
- Balanced needle and head construction
- Hand tool and 4 needles included
- Splicing tool for up to 5mm line
- Different needle lengths available on request

2 62050

Photo No.	Product No.
2	Easy splice

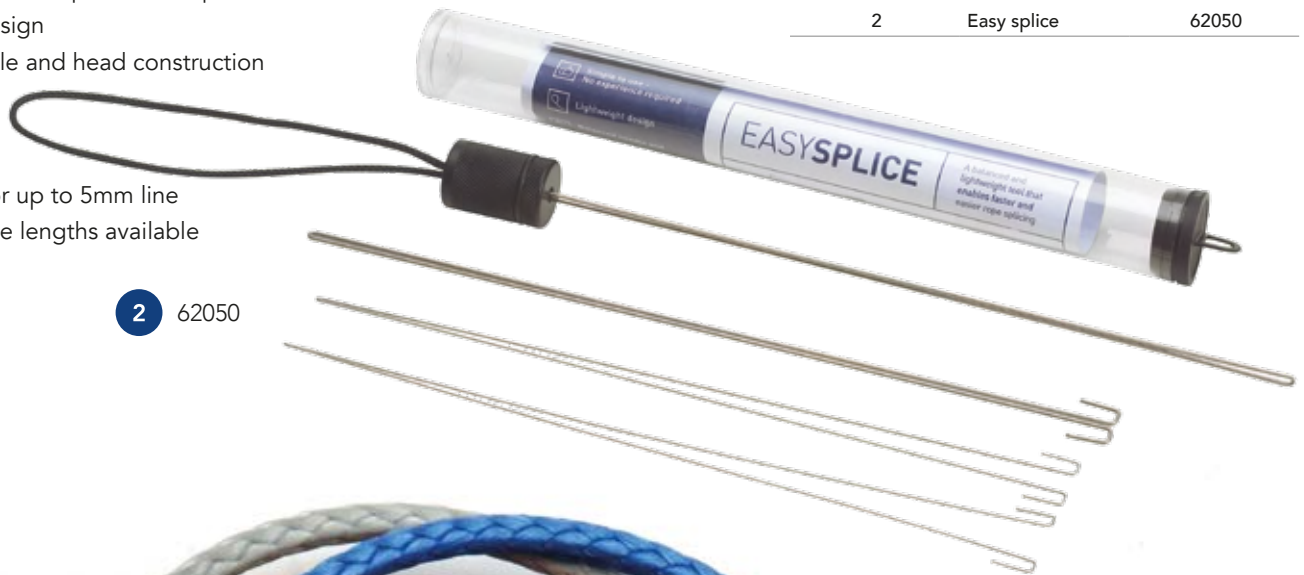

Barton

Barton Marine Equipment Limited

Marine House

Tyler Way

Whitstable

Kent CT5 2RS UK

t: +44 (0) 1227 792979

f: +44 (0) 1227 793555

e: sales@bartonmarine.com

w: www.bartonmarine.com

