

SCALE 2:1

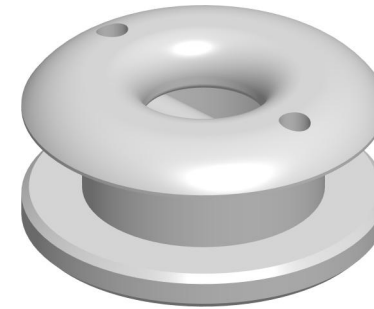

COLOURS AVAILABLE: Blue and Black  
Others available upon request with an increased lead time.

**Specification**

Distance Between Holes mm	Outside Diameter mm	Fixing Hole Diameter mm	Fixing Hole Depth Minimum mm	Fixing Hole Depth Maximum mm	Breaking Load Kg	Maximum Working Load Kg
17	24	16	6	8	400	300

**DIMENSIONS FOR REFERENCE ONLY**  
allenbrothers.co.uk  
+44(0)1621 772477

Title	Description
<b>A8739-6-REF</b>	<b>Pad-Tii</b>