

A2030P

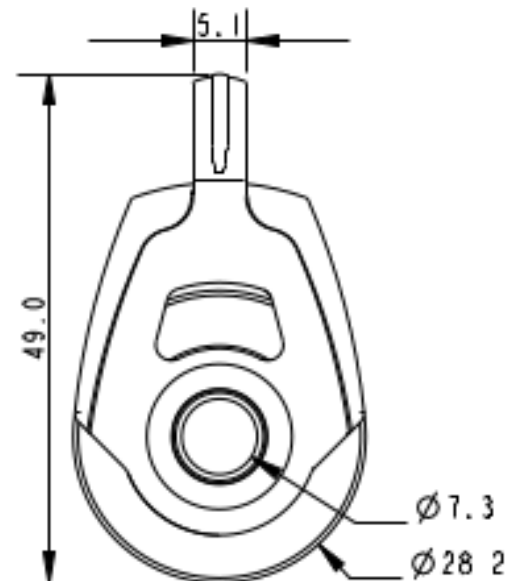

- Product Description: Plain Bearing Block
- Sheave Diameter: 30mm
- Length: 49mm
- Max Line Diameter: 8mm
- Breaking Load: 750Kg
- Weight: 23g

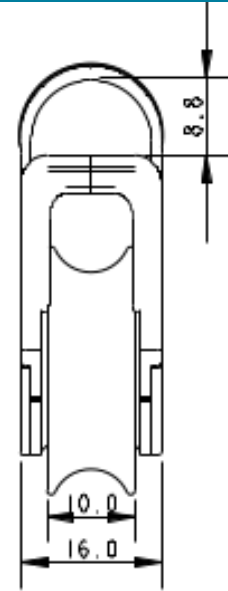

Details: The A2030P is a modern replacement for the A4280P. Offering a variety of modern performance and manufacturing upgrades that ensure a more eco-friendly and performance orientated product. The A2030P is made using 100% recycled plastics and the well-known Allen Ultra-Strap. This combination results in a 20% weight saving over the existing range as well as improving the overall performance. This block looks very similar to the 30mm Dynamic version. To differentiate we have changed the sheave colour to grey.